



# 75MM MAXIWALL HOUSE & LOW-RISE MULTI-RESIDENTIAL EXTERNAL WALL SYSTEM **TECHNICAL GUIDE**



## **MAXIWALL 75MM (VERTICAL)** HOUSE & LOW-RISE MULTI-RESIDENTIAL EXTERNAL WALL SYSTEM **TECHNICAL GUIDE**



WE'RE  
BIG RIVER  
GROUP

  
**BIG RIVER**  
COMMERCIAL

  
**BIG RIVER**  
TRADE CENTRE

  
**BIG RIVER**  
PANELS

  
**TIMBERWOOD**  
PANELS

  
**PLY/TECH**  
PANELS

## **ABOUT BIG RIVER**

With over 110 years in the timber industry, Big River is now one of Australia's largest timber manufacturing and marketing businesses, with a diverse business servicing all Australian States and many international projects.

Big River owns and manages sales and distribution outlets across Australia servicing the construction and building industry as well as the manufacturing sector with a diverse range of timber products and other associated construction materials such as Maxiwall – a strong yet lightweight walling panel made from Autoclaved Aerated Concrete (AAC).and reinforced with corrosion protected steel mesh.

Maxiwall is sourced from world class production facilities using the latest technology and automated processes to ensure each Maxiwall panel is of optimum quality and consistency.

Big River provides customers with the security of a full support network, and technical expertise at every stage of the product lifecycle. This is the guarantee of quality and service that Big River has based its 100 years of success on.

## 1.0 CONTENTS & USE OF MANUAL

<b>MaxiWall Panel</b>	<b>4</b>	<p>This technical guide contains design, installation and technical information intended for use as a general guide by qualified design and building construction professionals including licensed builders in the construction of external walls for low-rise multi-residential buildings.</p> <p>This document does not substitute the necessary knowledge, experience and judgment of qualified design and building construction professionals. They should be consulted to ensure that the specific building systems, its components and installations are suitable for the projects and conform to building codes under Australian laws.</p> <p>Big River is not responsible for ensuring the correctness or suitability of the systems or compliance with federal, state or local laws and regulations, including building, environmental and other codes.</p>
<b>Advantage &amp; Benefit</b>	<b>5</b>	
<b>MaxiWall External Wall System</b>	<b>6</b>	
<b>Design Consideration</b>	<b>7</b>	
<b>Fixing Specification</b>	<b>8</b>	
<b>System Component</b>	<b>9</b>	
<b>Installation Detail</b>	<b>10</b>	
<b>Product Declaration</b>	<b>26</b>	
<b>Coating &amp; Weatherproofing</b>	<b>29</b>	
<b>Material Handling</b>	<b>30</b>	
<b>Material Property</b>	<b>31</b>	
<b>Standard &amp; Compliance</b>	<b>32</b>	
<b>Responsibility &amp; Warranty</b>	<b>33</b>	

## 2.0 MAXIWALL PANEL

The Maxiwall Autoclaved Aerated Concrete (AAC) wall panel is a durable, lightweight, steel reinforced innovative building panel that offers excellent benefits as an external wall system for low-rise residential buildings. Some of the benefits include:

- Environmentally friendly – no toxic gases or hazardous waste
- Quick installation – reduced time and labour costs
- Fire resistant – helps prevent spread of fire
- Energy efficient – high thermal mass and thermal isolation
- Excellent soundproofing – reduces noise transmission significantly
- Durability – not affected by harsh climatic conditions

Maxiwall wall panels are manufactured using the latest state-of-the-art German production technology and plant. Made from cement, fine aggregates, lime and water, an expansion agent is added to the mixed slurry which causes it to rise like dough containing closed air pockets that results in its lightweight and energy efficient benefits. The material is molded and wire-cut into dimensioned panels and cooked with steam (autoclaving). AAC has been used in Europe for more than 70 years and continues to be widely accepted in Australia since its introduction over 20 years ago.

Building homes with Maxiwall wall panels will deliver a quieter, cooler and more comfortable “home living” experience. With four times greater thermal resistance than standard house bricks, the amount of energy required to heat or cool is greatly reduced thus resulting in cost savings to homeowners.

Maxiwall wall panels are lighter than other concrete and masonry products allowing for faster installation, easier handling and more flexible solutions to external wall system requirements.

Maxiwall wall panels are available in the following dimensions and steel reinforcement.

<b>Thickness:</b>	75mm 600mm
<b>Width: Length:</b>	1800 to 3000mm
<b>Reinforcement:</b>	Single steel mesh, centrally located
<b>Steel wire:</b>	4 x 4mm longitudinal and 6-8 transverse bars depending on panel length

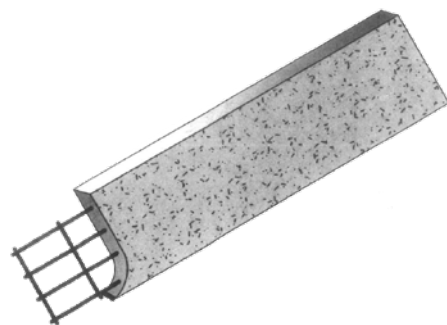



### 3.0 ADVANTAGE & BENEFIT



#### **STRONG & DURABLE**

MaxiWall steel reinforced panels have that solid feel of traditional bricks. With an approved external render finish MaxiWall is not affected by our harsh Australian climatic conditions and will not degrade under normal conditions.



#### **COST EFFECTIVE**

MaxiWall lightweight panels are easy to handle on-site with standard construction tools and quick to build with resulting in lower labour costs.



#### **FIRE RESISTANT**

MaxiWall is manufactured from aerated concrete and is non-combustible and therefore suitable for fire-rated applications such as boundary and party walls in residential and commercial applications.



#### **SAFE**

MaxiWall does not contain any toxic substances or odours, and will not harbour or encourage vermin.



#### **ENERGY EFFICIENT**

MaxiWall has a closed aerated structure which gives it superior thermal insulation properties compared to concrete or brick veneer. MaxiWall is therefore a smarter choice for lower heating and cooling energy consumption.



#### **SUPERIOR ACOUSTICS**

MaxiWall also has superior soundproofing and acoustic insulation properties.



#### **SUSTAINABLE**

MaxiWall is a cleaner, greener and more sustainable choice. On a volume comparison, MaxiWall has manufacturing, embodied energy and greenhouse gas emission impacts significantly less than those of concrete and bricks.



#### **COMPLIANT & BACKED BY BIG RIVER**

AAC was invented in Sweden over 70 years ago and is widely used in building throughout Europe as well as other regions in the world. Its popularity amongst architects, builders and homeowners in Australia has been growing significantly over the past 20 years.

MaxiWall is now available and supported in Australia through the established national sales and distribution network of the Big River Group

## **4.0 MAXIWALL EXTERNAL WALL SYSTEM**

The MaxiWall external wall system is designed for the construction of low-rise multi-residential buildings and houses using timber or steel frames. It can also be used for recladding of existing homes and extensions.

The system comprises of 75mm thick MaxiWall AAC wall panels embedded with reinforcing corrosion protected steel mesh in longitudinal and transverse directions, installed vertically over discontinuous or continuous horizontal battens fastened to the load bearing frames.

For fast, construction flexibility and the ability to make easy adjustments on site, the MaxiWall wall panels can be procured in standard lengths of 1800mm 2400mm, 2550, 2700mm, 2850 and 3,000 and in width of 600mm.

The MaxiWall external wall system has an advantage over other wall systems when plaster, stucco or render finishes are used, as no additional preparation work is required. MaxiWall panels can also be used as internal non-load bearing separating, shaft, partition and noise barrier walls.

## 5.0 DESIGN CONSIDERATION

For MaxiWall external wall system to be effective and economical the following design process to capitalise on the product benefits and architectural features is important.

Ascertain wind load, soil type and movement and wall frames layout.

When designing the system ensure it complies with the relevant BCA performance conditions below:

**Fire Resistance Level (FRL)**

**Sound insulation performance (Rw values)**

**Energy Efficiency (R-Value)**

Determine wall frame spacing, quantity of battens, screw fixing and cantilever distance (refer to Table 2 – Fixing Description). Select insulation and/or sarking material to meet energy efficiency requirements.

Ensure fire resistance level and sound insulation adequacy.

Decide on the exterior surface treatment, as pores of different size on the surface are an inherent characteristic of autoclaved aerated concrete.

Ensure Project Engineer verifies and approve completed detailed design and documentation as complying with BCA requirements.

The design considerations and installation details shown in this manual are for framed structural systems using MaxiWall panels. The system details show standard design configurations for MaxiWall panels that are used in a typical Australian dwelling house.

When designed and specified in accordance with the technical information contained in this manual, the MaxiWall external wall system for low-rise multi-residential buildings and houses shall be deemed to satisfy the requirements of the National Construction Code Series, Volume Two, Building Code of Australia (BCA) for Class 1 and Class 10a Buildings.

The standards and documents referred to in Appendix A of this manual are to be used to determine resistance to actions and to evaluate the material and system performance against the BCA nominated requirements.

The BCA is a performance based document available in two volumes: Volume 1 – Class 2 to Class 9 Buildings and Volume 2 – Class 1 and 10 Buildings (Housing Provisions). It is a uniform set of technical provisions used for the design and construction of buildings and other structures in Australia.

The MaxiWall panel has been issued with CodeMark™ Certificate of Conformity. This certification provides a nationally and internationally accepted process for products assessment for compliance.

## 6.0 FIXING SPECIFICATION

The fixing system is established according to the wind category at the site and method of construction, either with the panels fixed at the base, or with the panels suspended from the frame. The MaxiWall panel is fixed to the structural support framing with 24mm or 35mm cold formed top hat section battens to AS 3566.1 – 2002.

**TABLE 1. - FASTENERS AND FIXINGS**

CONNECTION	FIXING
Top hat to timber frame	12 - 11 x 35mm Hex Head Type 17 Screw or 5.5 x 40mm batten zips
Top hat to steel stud frame	10 - 16 x 16mm Hex Head Tek's Screw
Top hat to MaxiWall panel	14 - 10 x 65mm Hex Head Type 17 Screws**
MaxiWall panel to top hat	14 - 10 x 90mm Hex Head Type 17 Screw 14 - 10 x 100mm Bugle Head Screw
Recommended battens (24mm)	0.42 BMT or greater
Recommended battens (35mm)	0.55 BMT or greater

### FIXINGS DETAILS

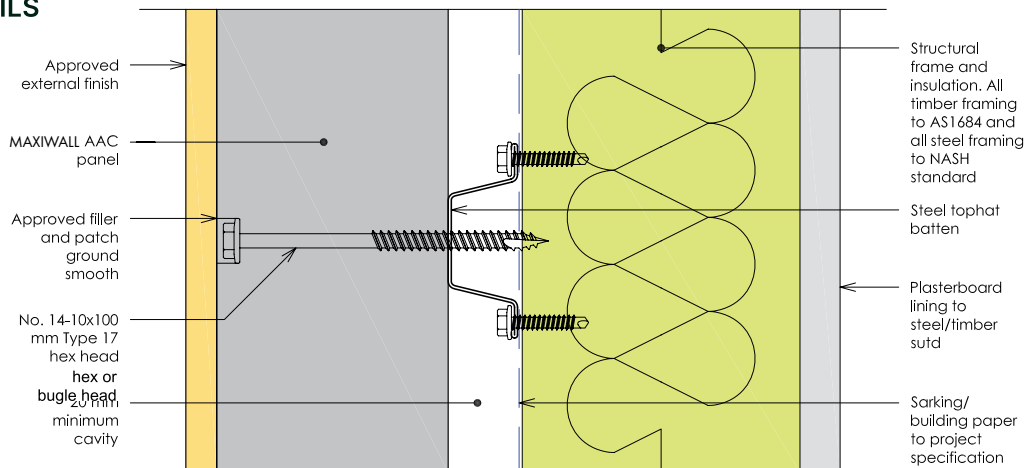

**TABLE 1. - FASTENERS AND FIXINGS**

WIND CLASS	MAXIMUM BATTEN SPACING (MM)		PANEL FIXING REQUIRED PER PANEL PER BATTEN (PCS)		MAXIMUM CANTILEVER DISTANCE AT PANEL END (MM)		STUD SPACING
	General Areas	Corners	General Areas	Corners	General Areas	Corners	
N1	1200	1200	2	2	400	400	600
N2	1200	1200	2	2	400	400	600
N3	1200	900	2	3	400	400	600
N4	1200	700	3	3	400	350	450
N5	750	700	3	4	350	350	450

## 7.0 SYSTEM COMPONENT

<b>Sarking Builders Wrap</b>	<p>Must be compliant with AS/NZ 4200.1 : 2017 and AS/NZ 4200.2 : 2017 Refer also state &amp; territory specific zone requirements.</p>
<b>Thick-Bed Mortar</b>	<p>A thick-bed bonding mortar with high adhesion strength specifically manufactured for the placement of MaxiWall panels where levelling and bonding application is required for external wall construction.</p> <p>The mortar helps in the integrity of an airtight construction for sound insulation and fire protection at the base of the panels.</p>
<b>AAC Adhesive</b>	<p>The adhesive for MaxiWall panels is a factory prepared blend of carefully selected raw materials such as cement, graded aggregates and strengthening and performance additives. It is a dry mixed product used as a structural thin bed adhesive for adhering the panels in the construction of external walls.</p>
<b>Patch Compound</b>	<p>A pre-mixed, water based jointing and patching compound used for repairing minor chips, cracks and damages particularly to the corners and edges. It can also be used as a filler compound.</p>
<b>Joint Sealant</b>	<p>Designed for sealing joints and wall penetrations that are subjected to high humidity and movements. The joint sealant provides superior integrity for fire and acoustic sealing. Even when excessively stretched sealants help maintain the joint's integrity.</p>
<b>Control Joint Packing</b>	<p>10mm ableflex/backing rod or equivalent</p>
<b>Anti-Corrosion Paint</b>	<p>Used for coating and protection of the exposed steel reinforcement mesh from corrosion after cutting.</p>
<b>Render Coating</b>	<p>Acrylic modified cement based renders designed to provide weather resistant, attractive decorative and durable finishes for application over MaxiWall panels.</p>

Note: System components are supplied by approved supply partners.

## 8.0 INSTALLATION DETAIL

### Single storey construction - Isometric view

1a

- Panel supported at base

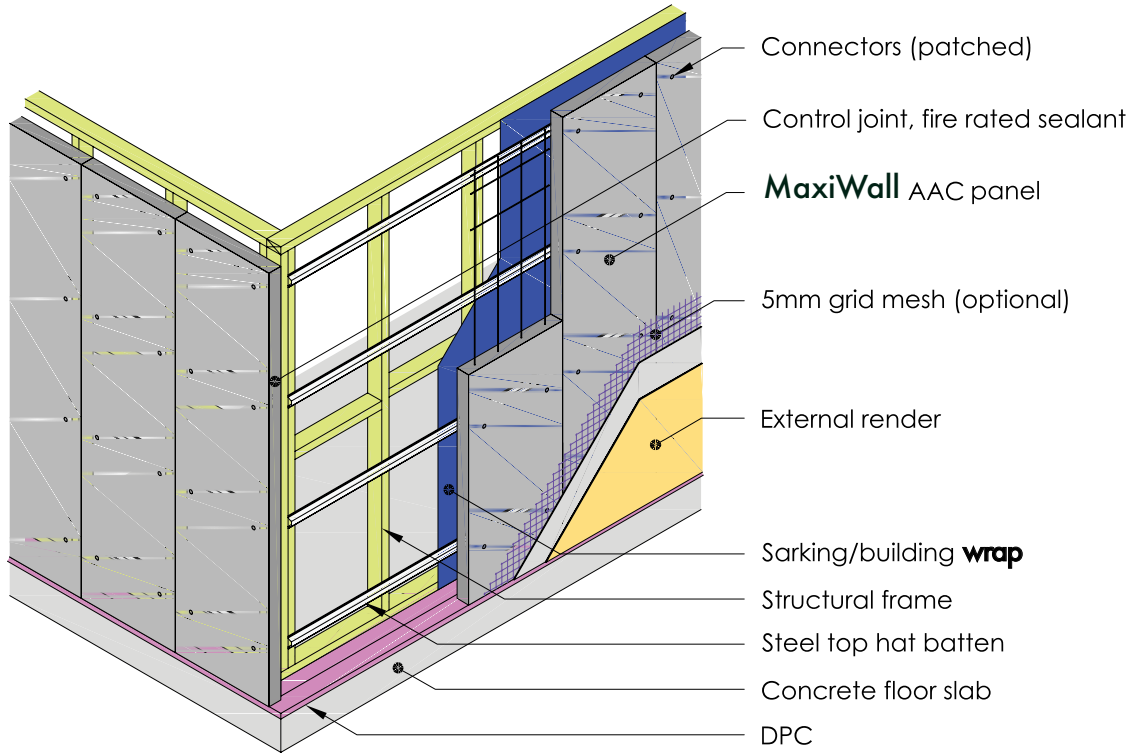

1b

- Panel suspended from wall frame

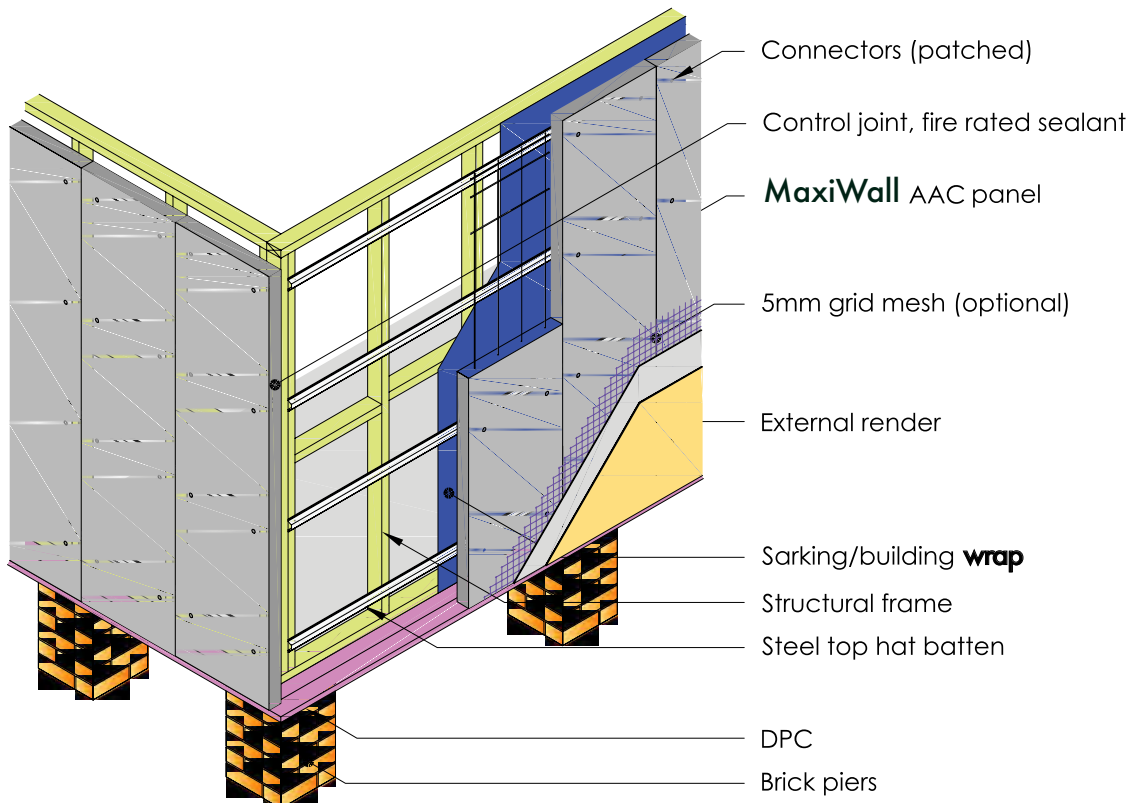



## 2a Detail Elevation - Single Storey Construction

Hip Roof Elevation

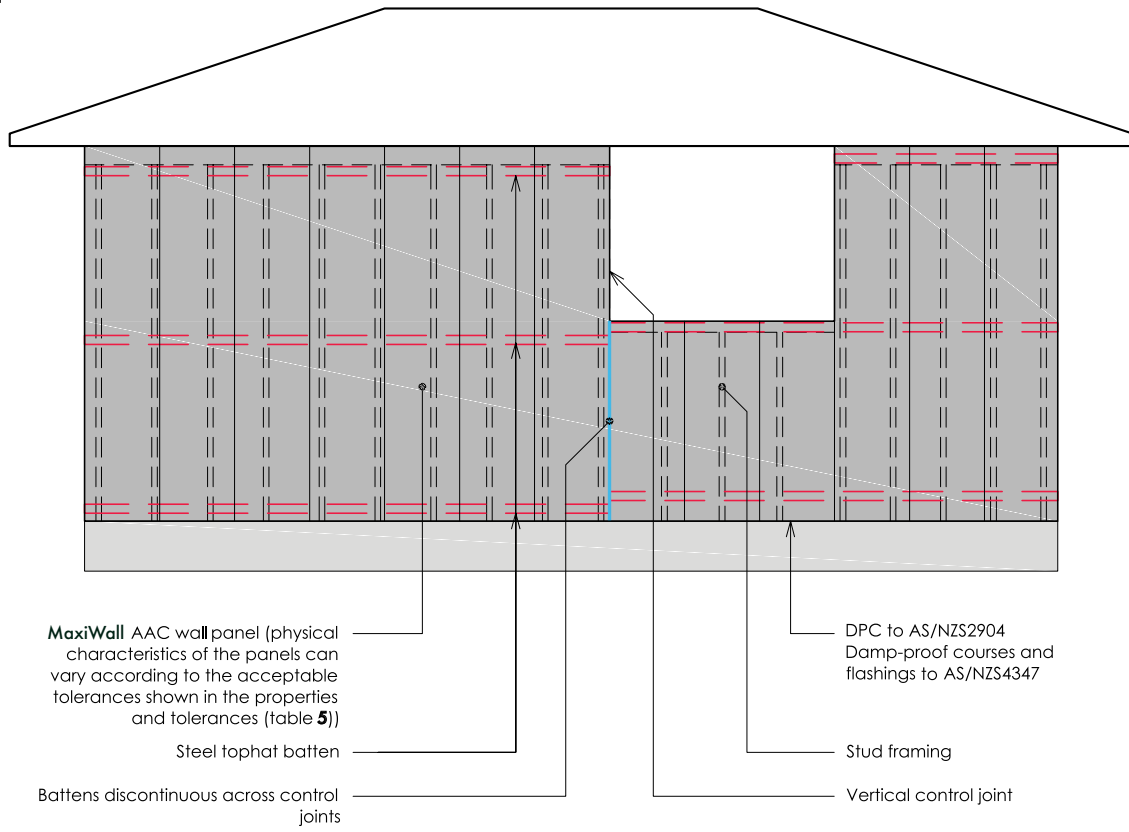

## 2b Detail Elevation - Single Storey Construction

Gable End Elevation

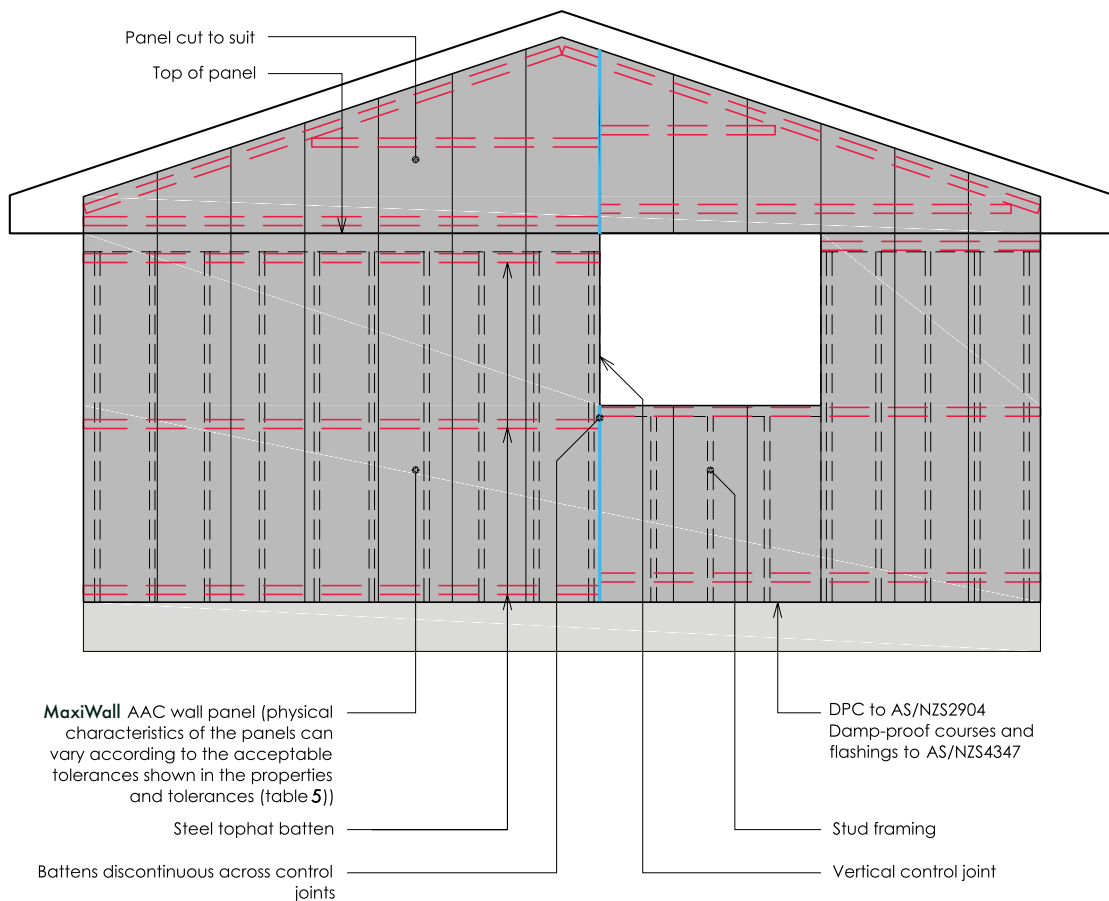

### 3a - Single storey House Design

Detail section -  
Timber frame with suspended floor  
Panels suspended from frame

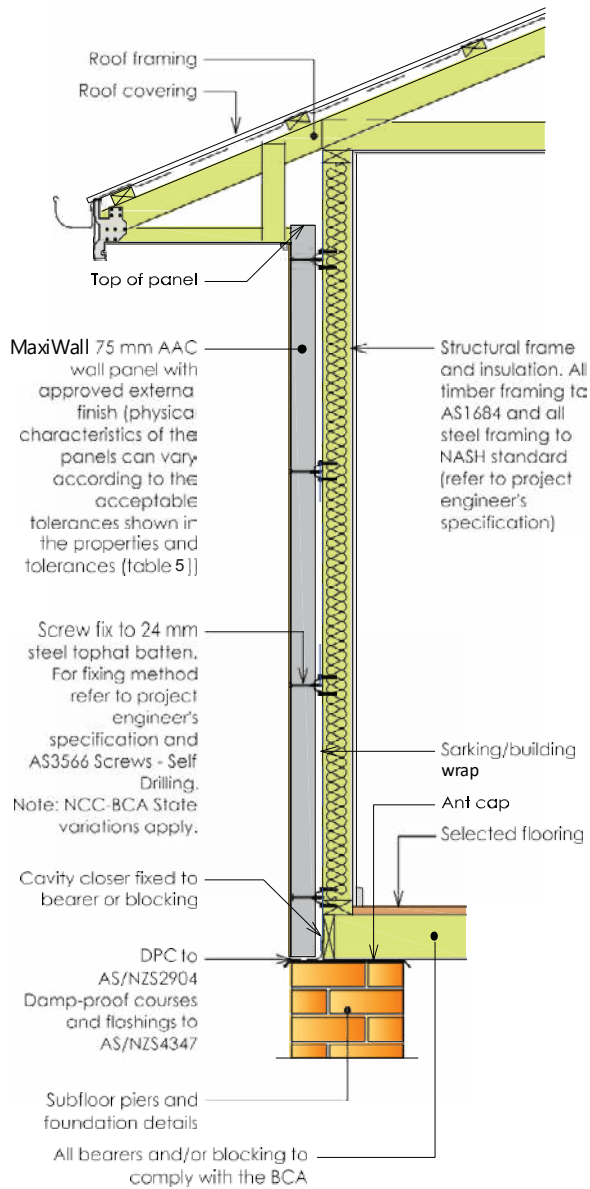

### 3b - Single storey house design

Detail Section -  
Steel frame with in-situ concrete slab  
Panels supported on slab

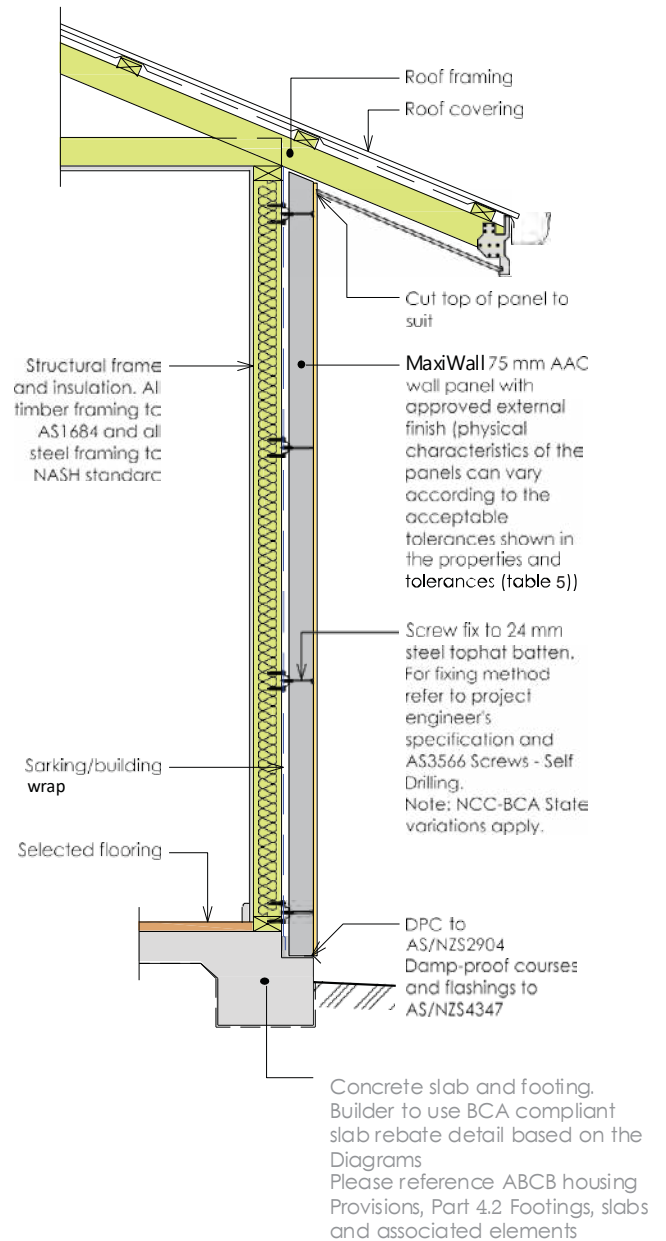

#### 4a Two Storey Design

Typical timber frame section  
Window and horizontal control joint

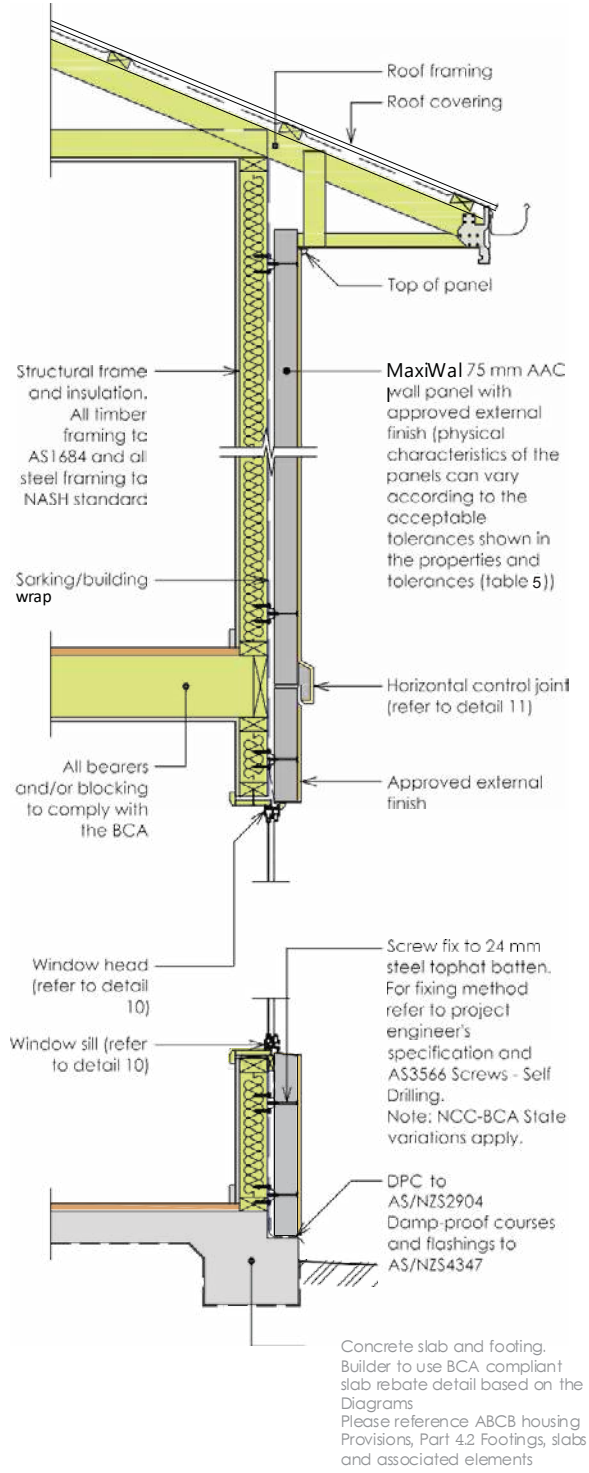

#### 4b Two storey design

Typical steel frame section or engineered timber joists  
Decorative facade treatment

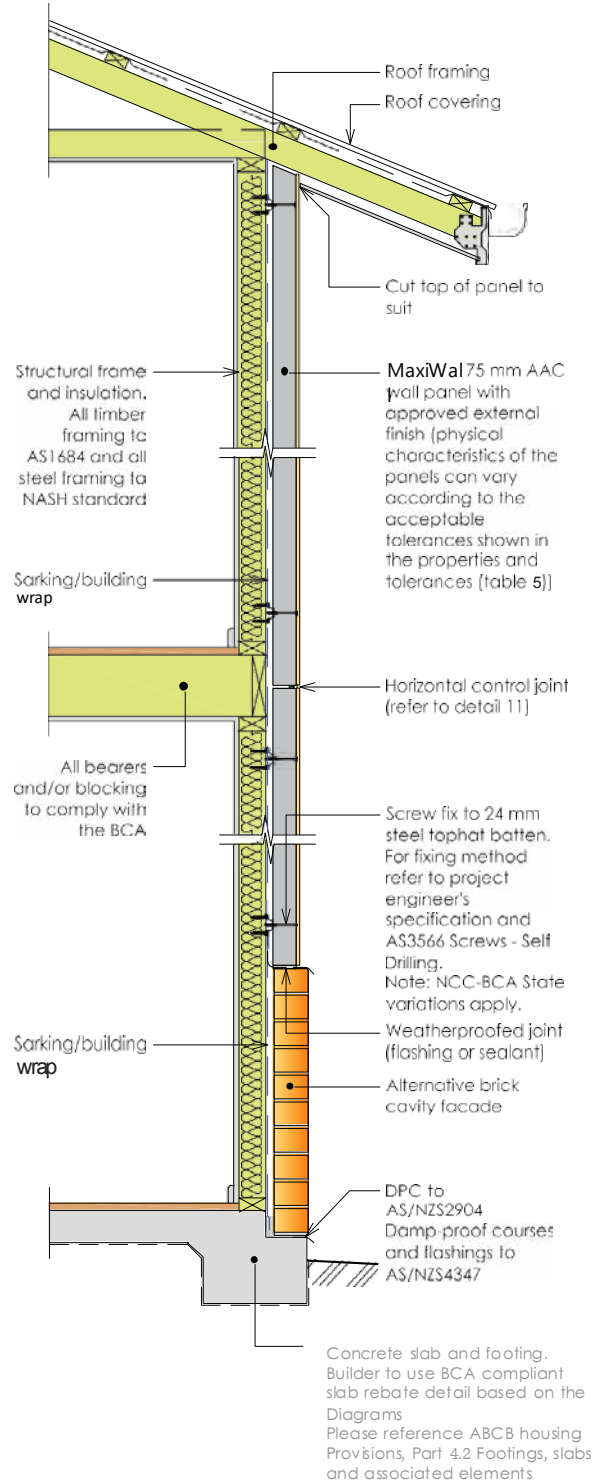

## 5 Detail Elevation - Two Storey Construction

Skillion End Elevation

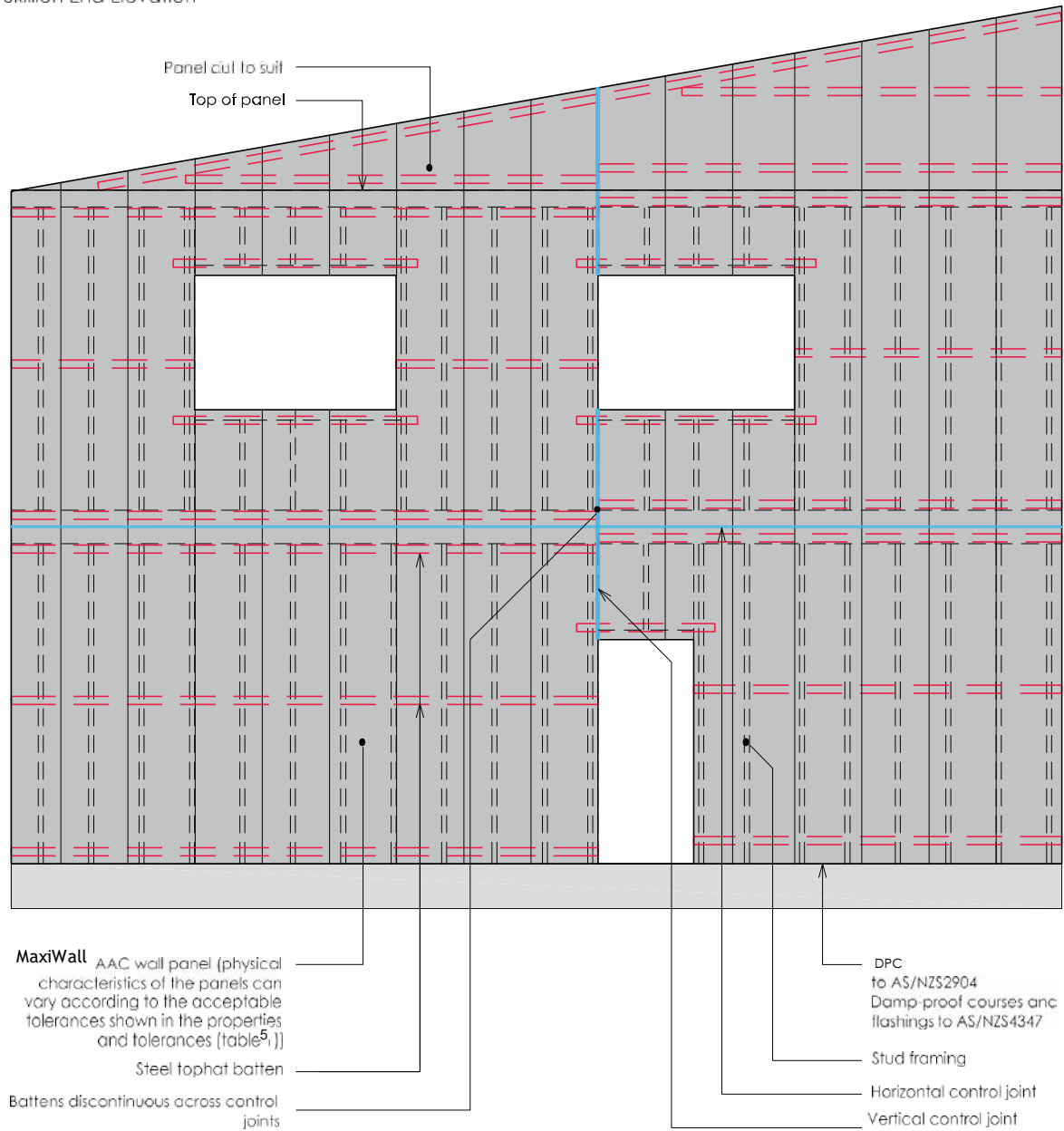

### 6a Detail Section - External Wall System Fixing

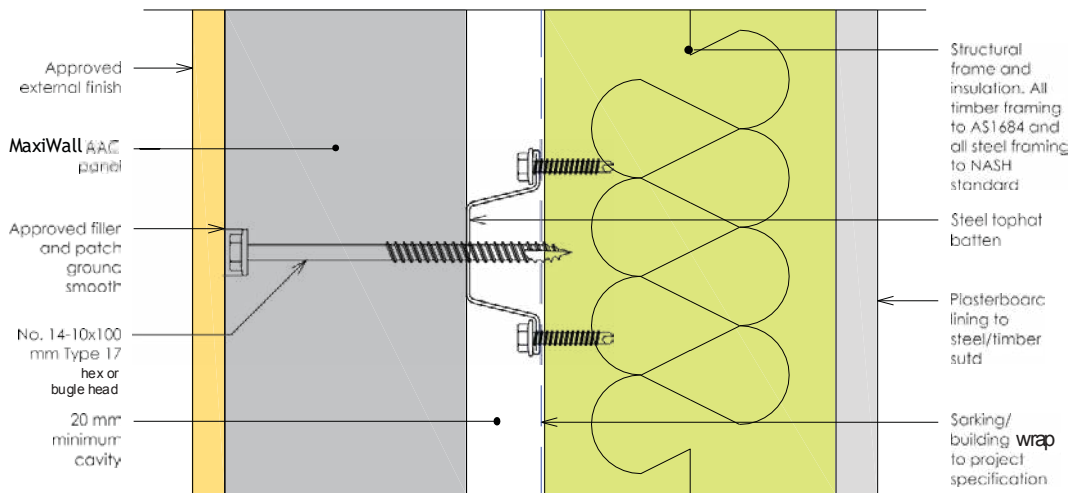

### 6b Detail Elevation - Screw Layout Drawing

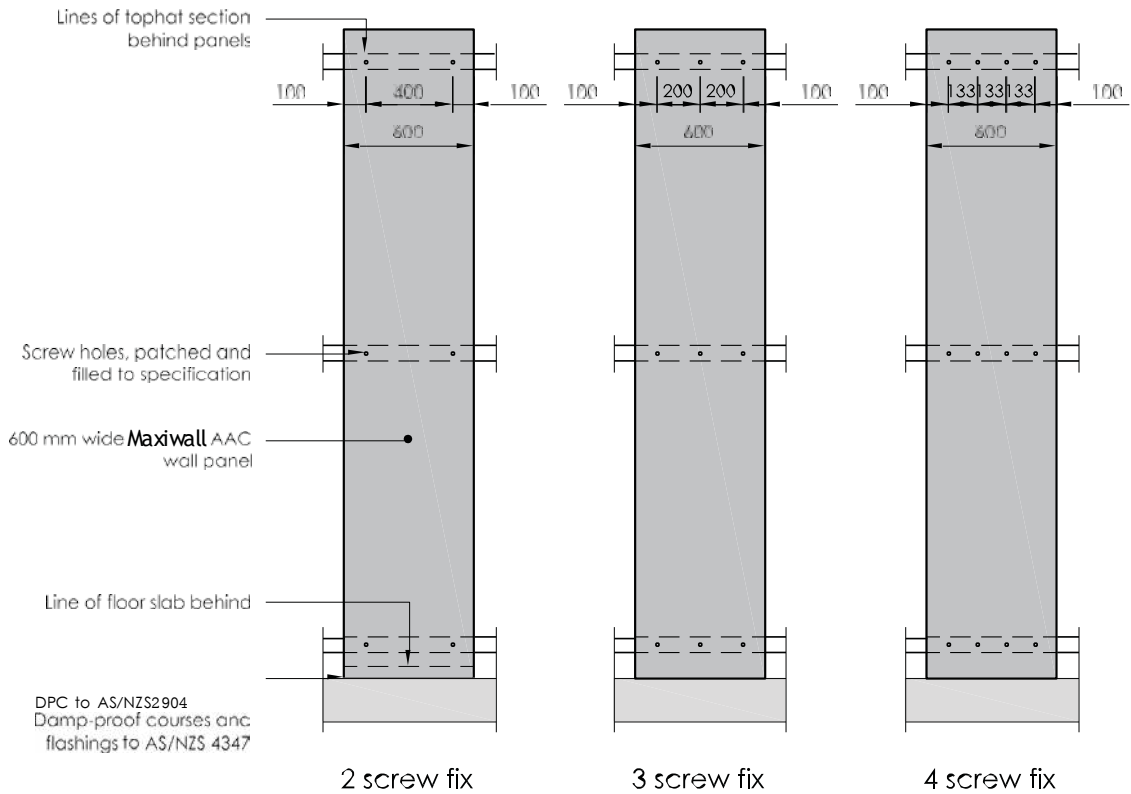

7a Footing Junction Detail  
 - Suspended Panel (brickwork pier)

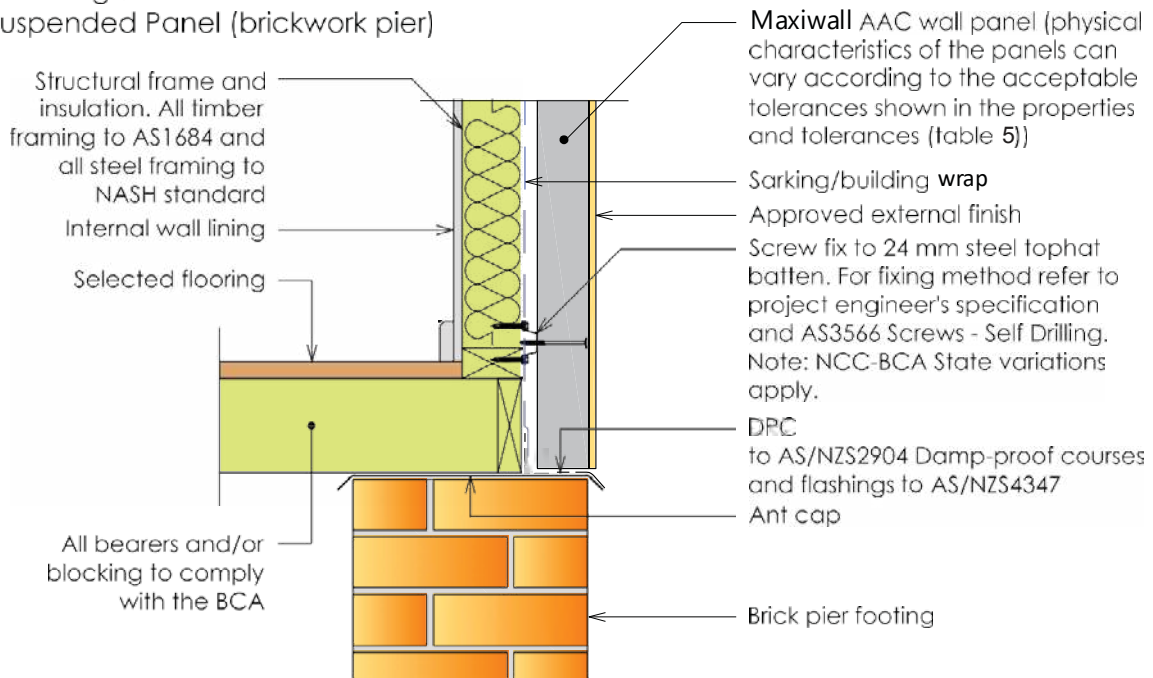

7b Footing Junction Detail  
 - Suspended Panel (rebated slab)

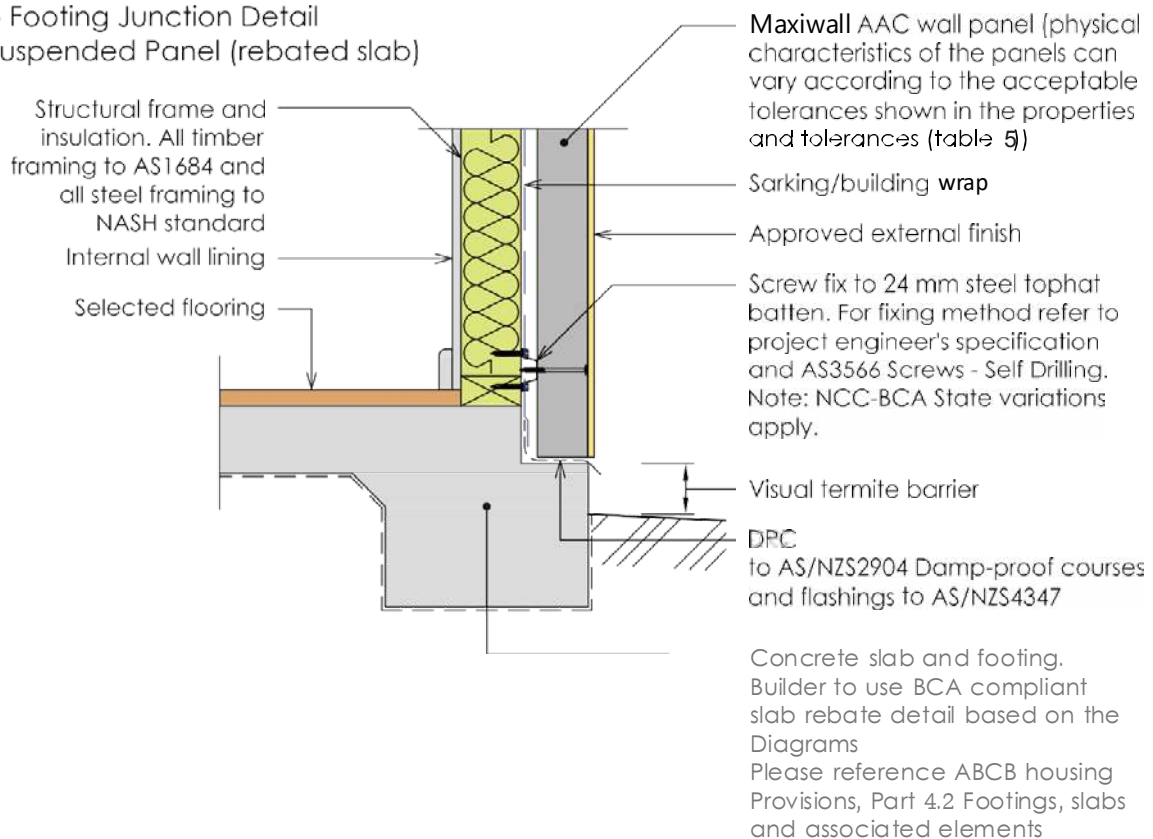



7c Footing Junction Detail  
- Panel on base

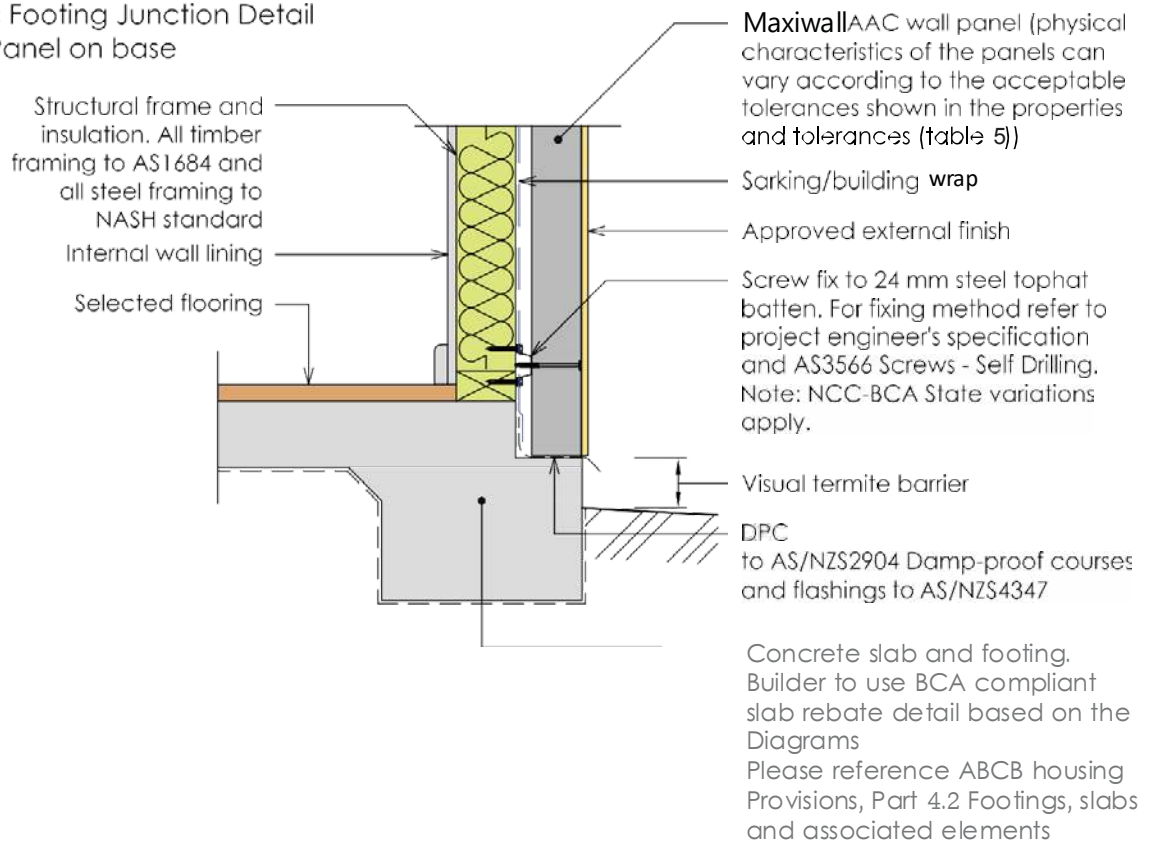

8a - Wall to Eaves Junction Detail  
- Panel to Soffit

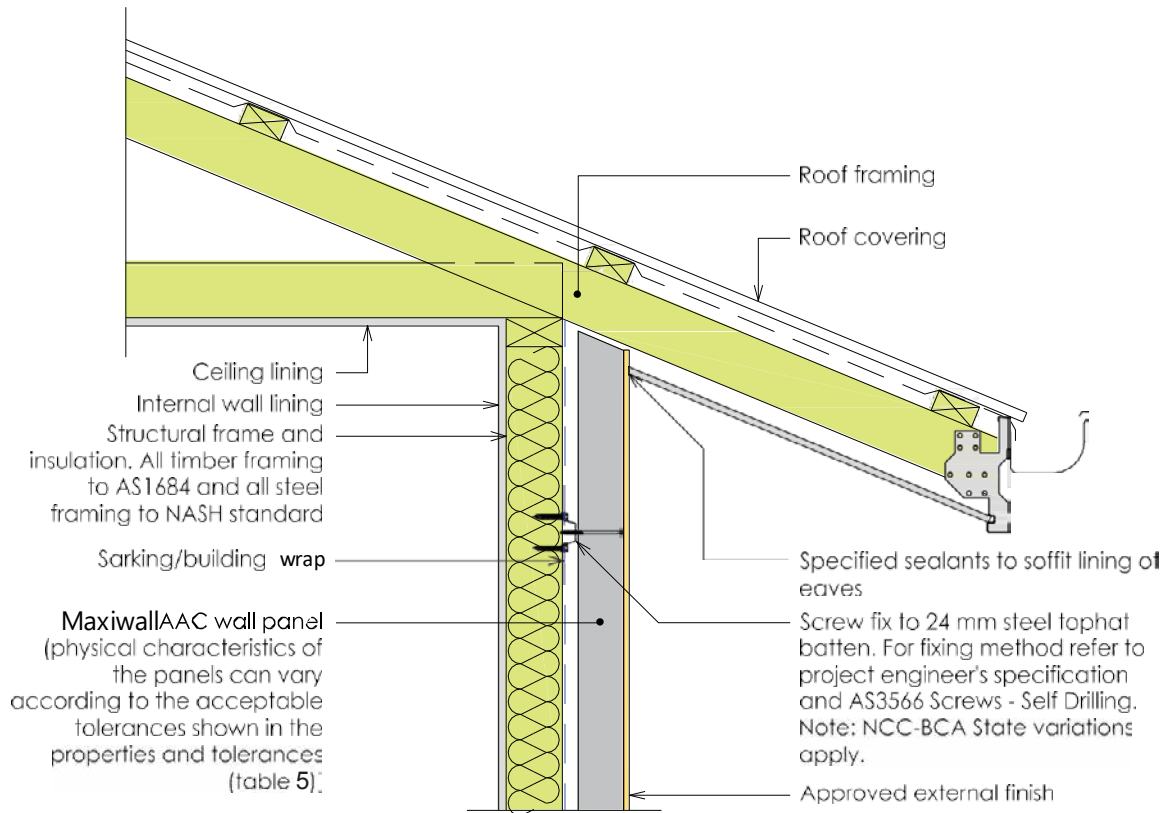

8b - Wall to Eaves Junction Detail  
- Panel to Underside of Frame

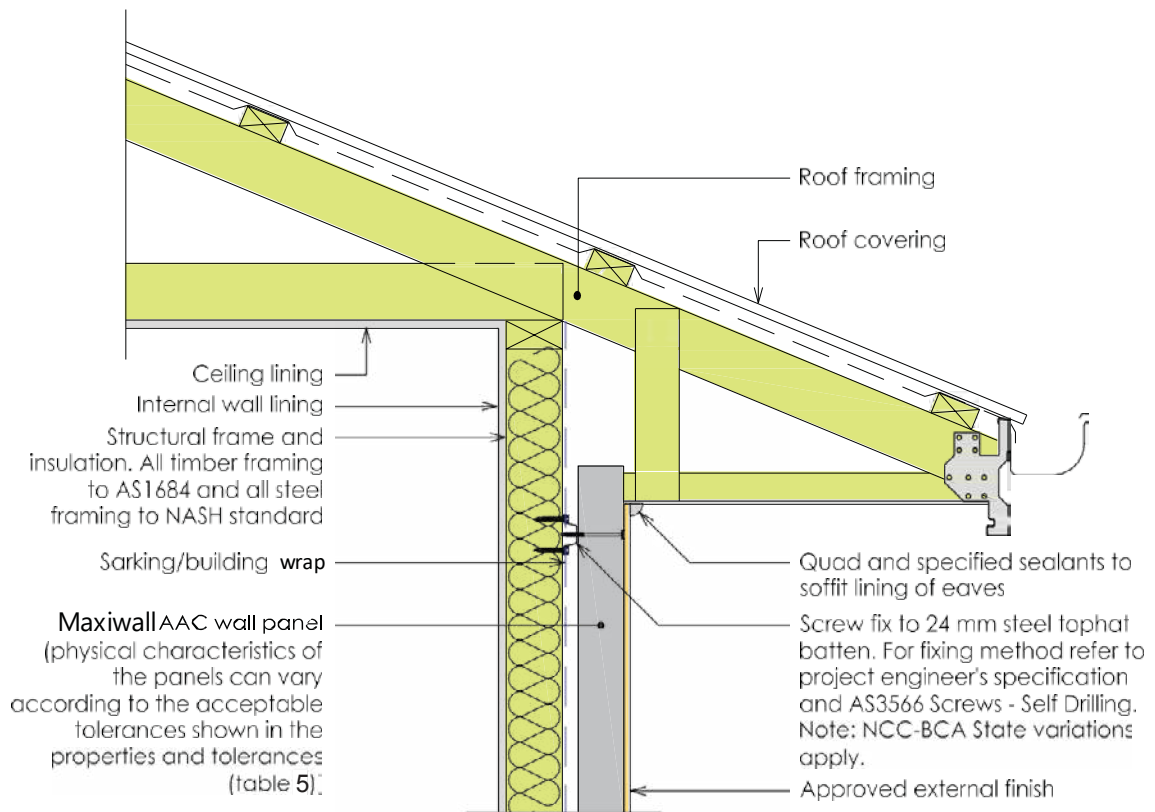

8c - Roof to Wall Junction Detail  
 - Parapet Capping

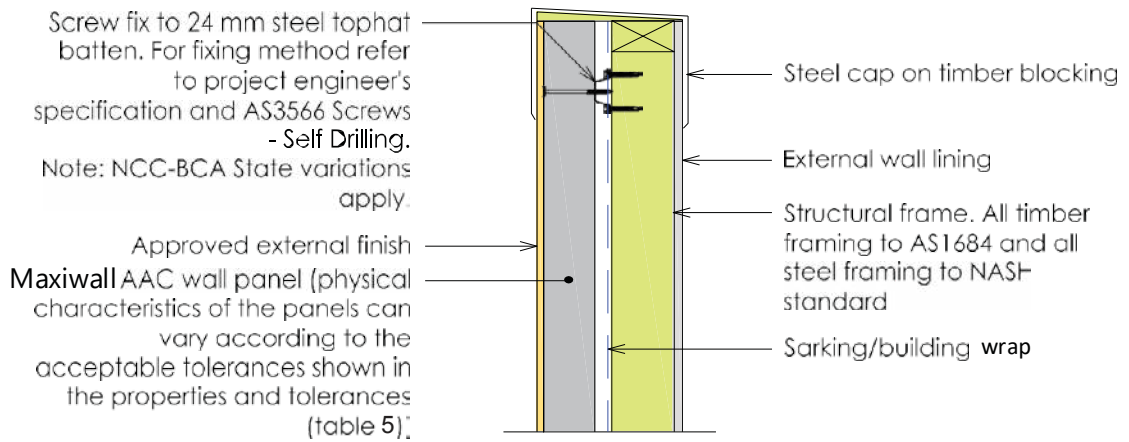

8d - Roof to Wall Junction Detail  
 - Skillion Roof

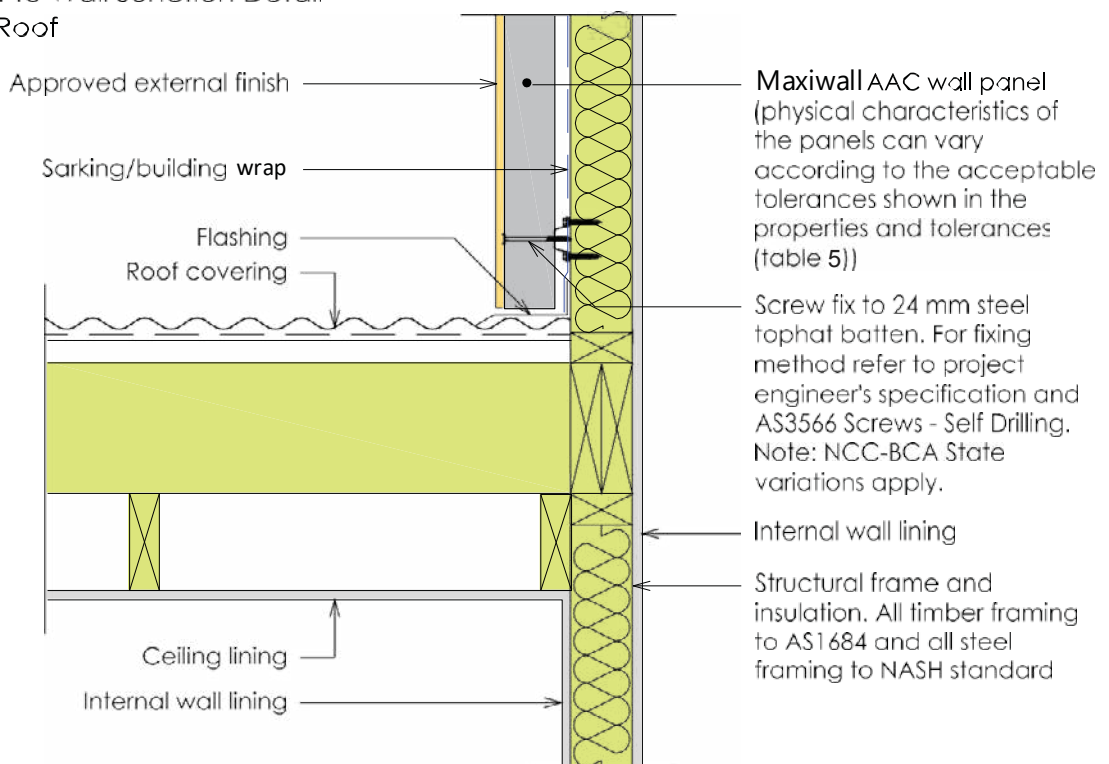

9a - Control Joint to Frame Detail  
 - Double stud

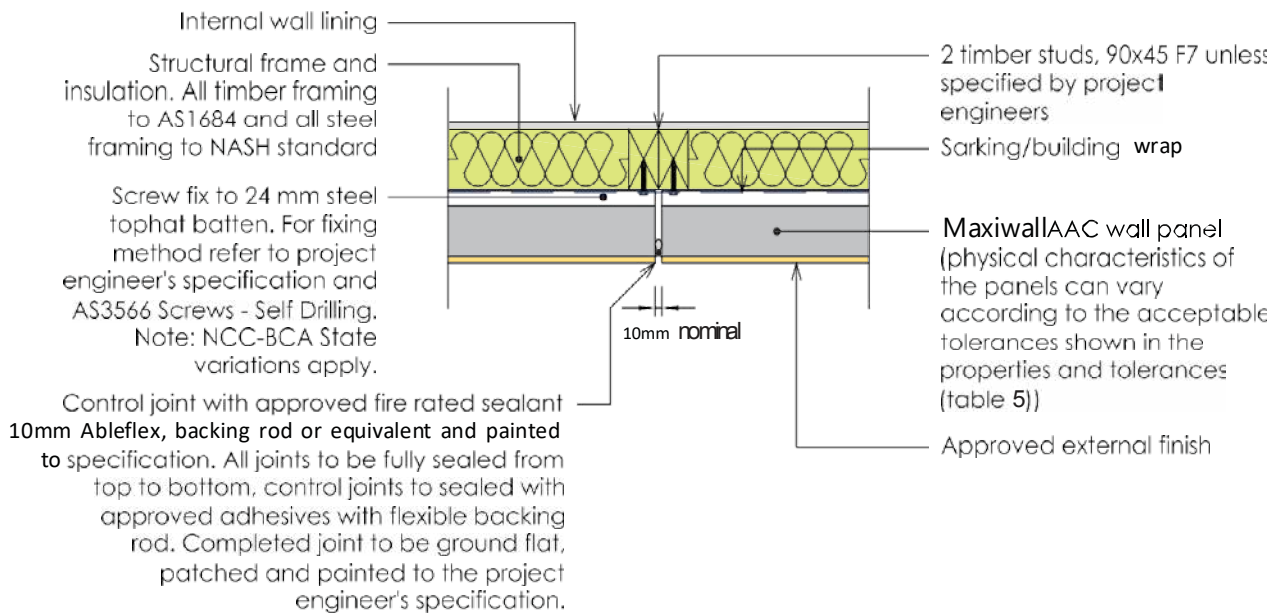

9b - Control Joint to Frame Detail  
 - Single stud

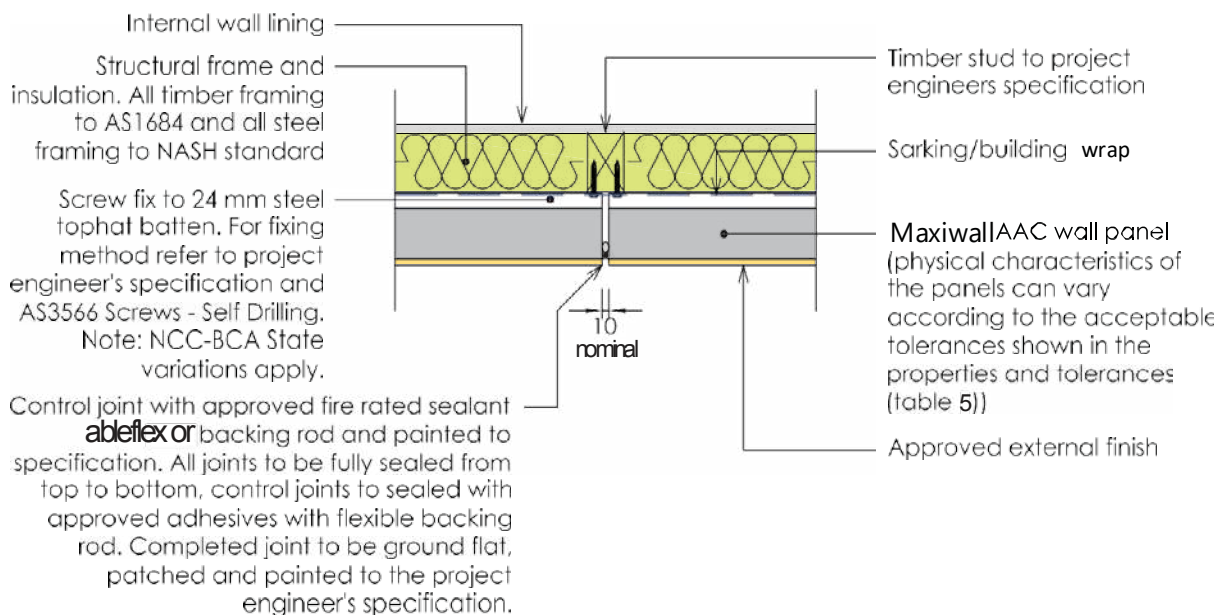

9c - Control Joint to Frame Detail  
- Internal Corner

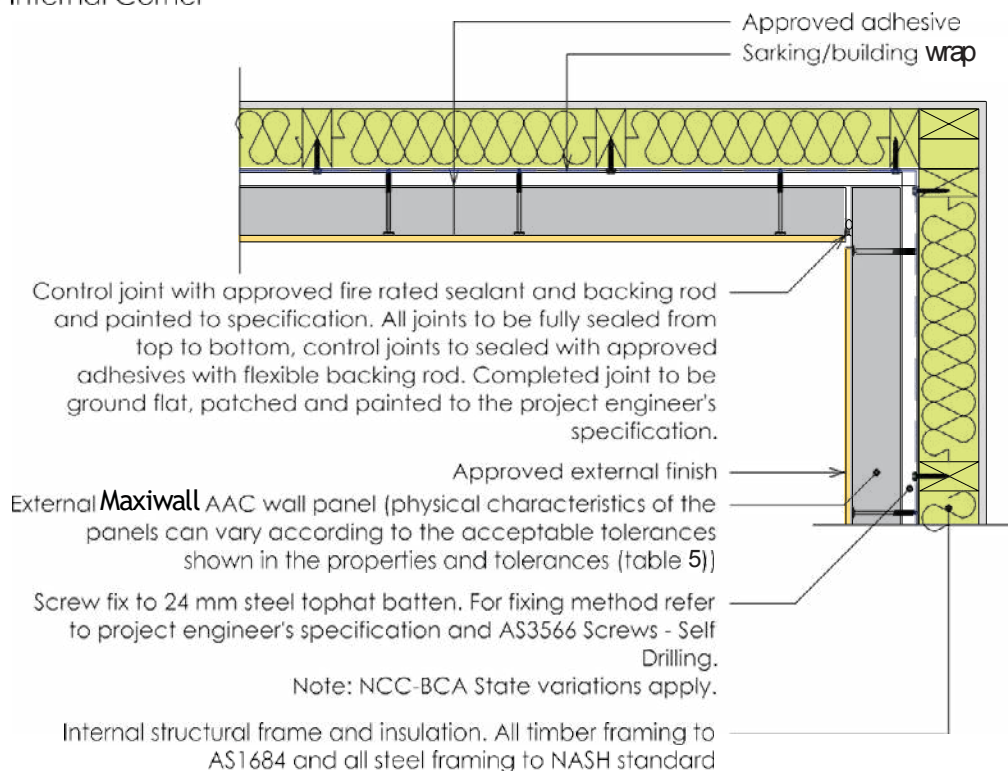

9d - Control Joint to Frame Detail  
- External Corner

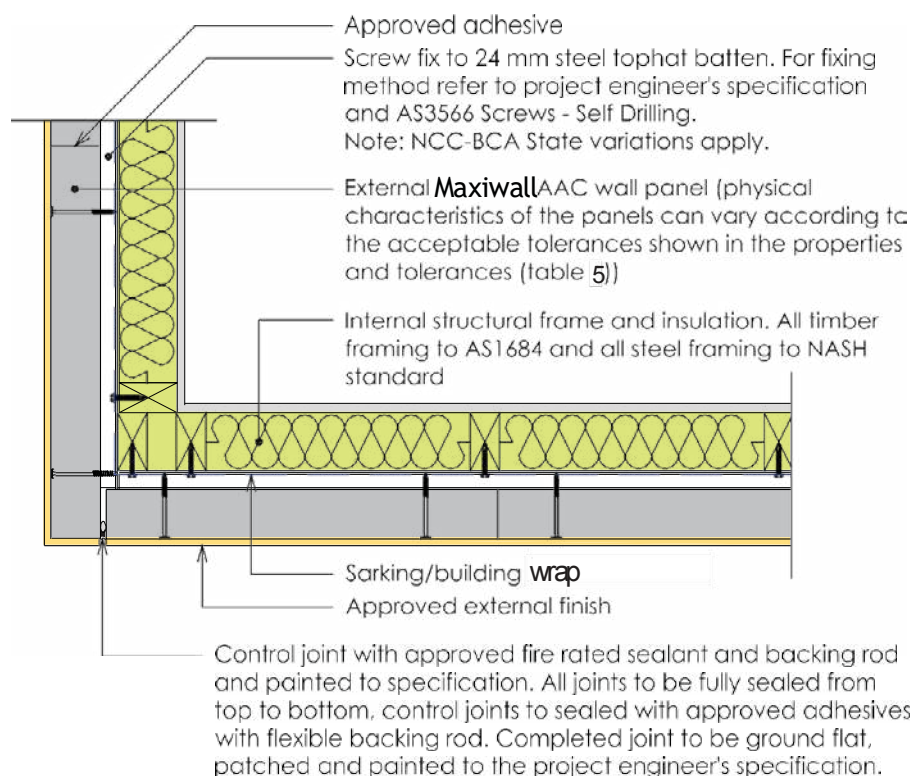

### 10a - Faux Column Cladding

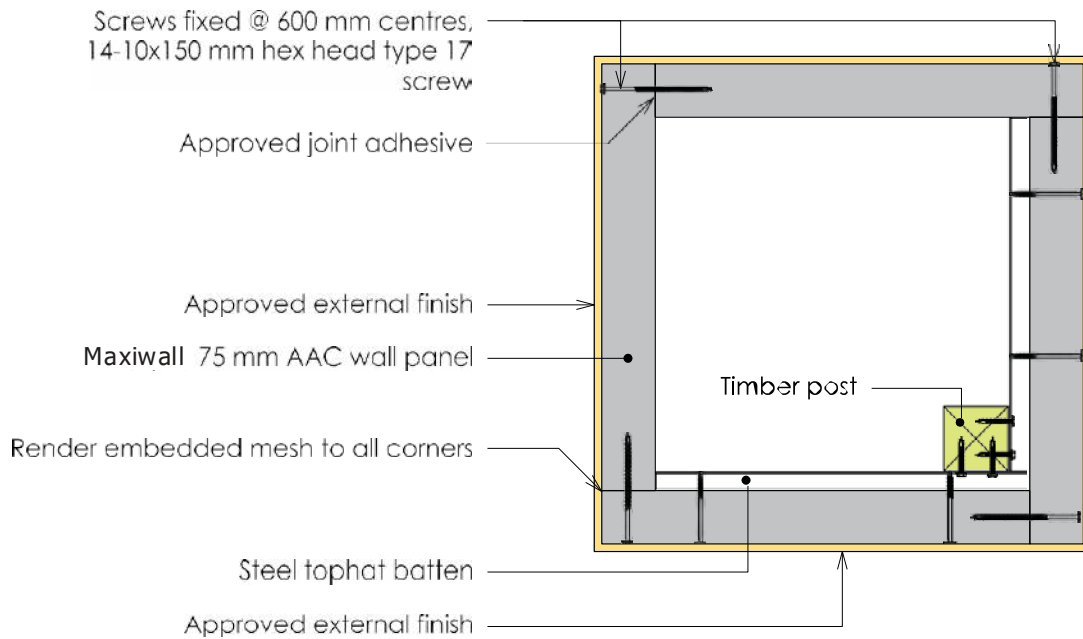

### 10b - Window Jamb

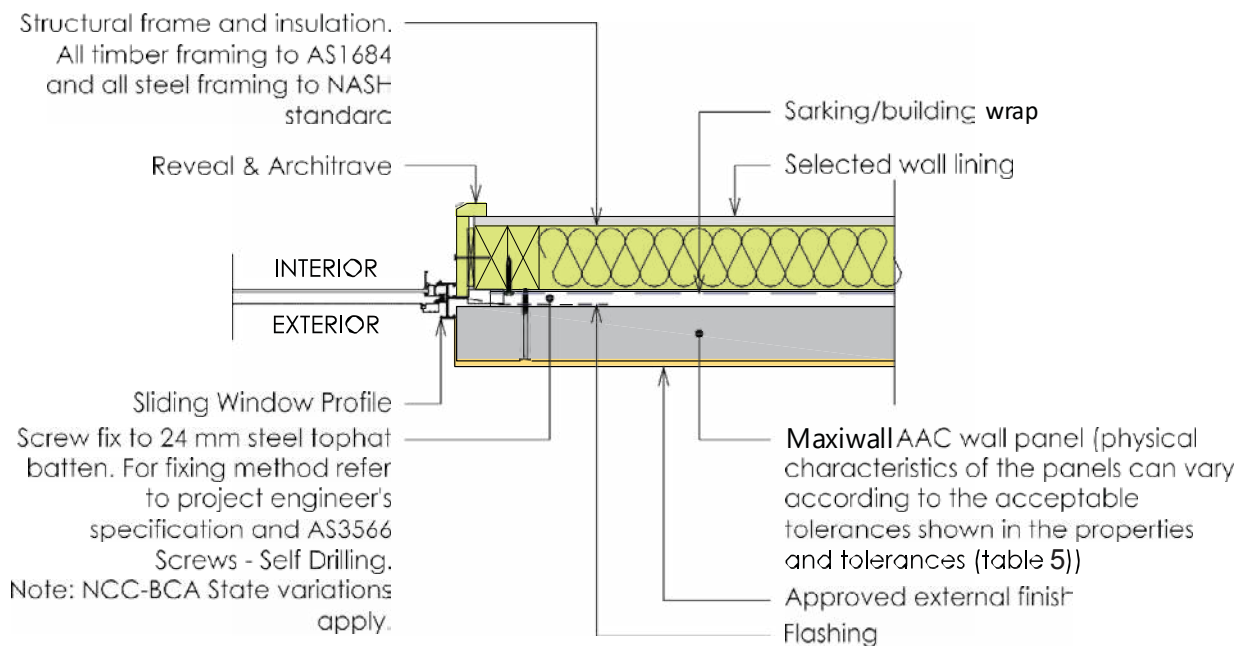



10c - Window Head

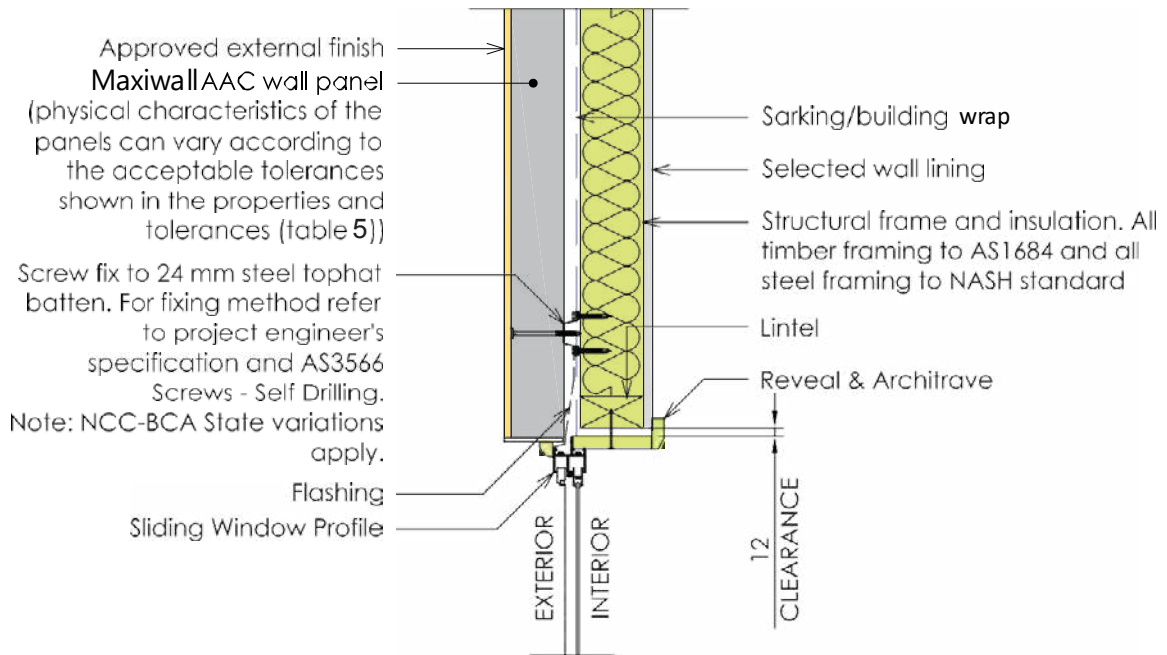

10d - Window Sill

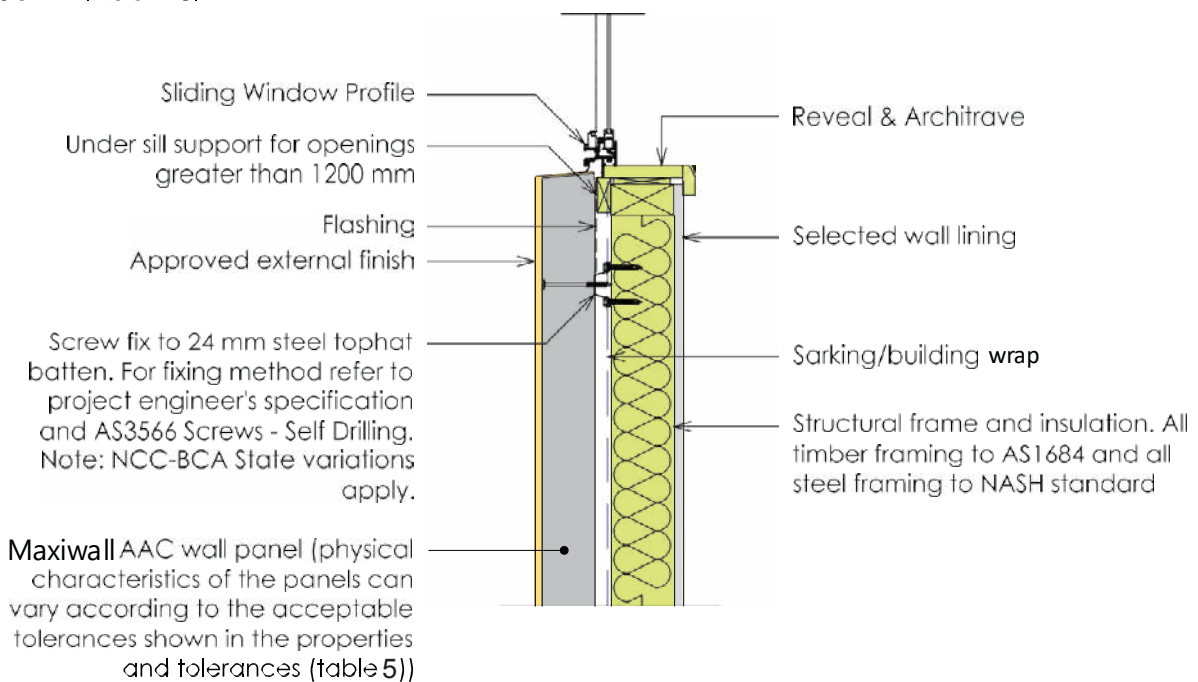

11a - Horizontal Control Joint  
- Moulding Finish

Maxiwall AAC wall panel (physical characteristics of the panels can vary according to the acceptable tolerances shown in the properties and tolerances (table 5))

Approved exterior coating

Screw fix to 24 mm steel tophat batten. For fixing method refer to project engineer's specification and AS3566 Screws - Self Drilling.  
Note: NCC-BCA State variations apply.

Moulding fixed to top panel, deflection gap as per project specification

Non compressible packer

Screw fix to 24 mm steel tophat batten. For fixing method refer to project engineer's specification and AS3566 Screws - Self Drilling.  
Note: NCC-BCA State variations apply.

Maxiwall AAC wall panel (physical characteristics of the panels can vary according to the acceptable tolerances shown in the properties and tolerances (table 5))

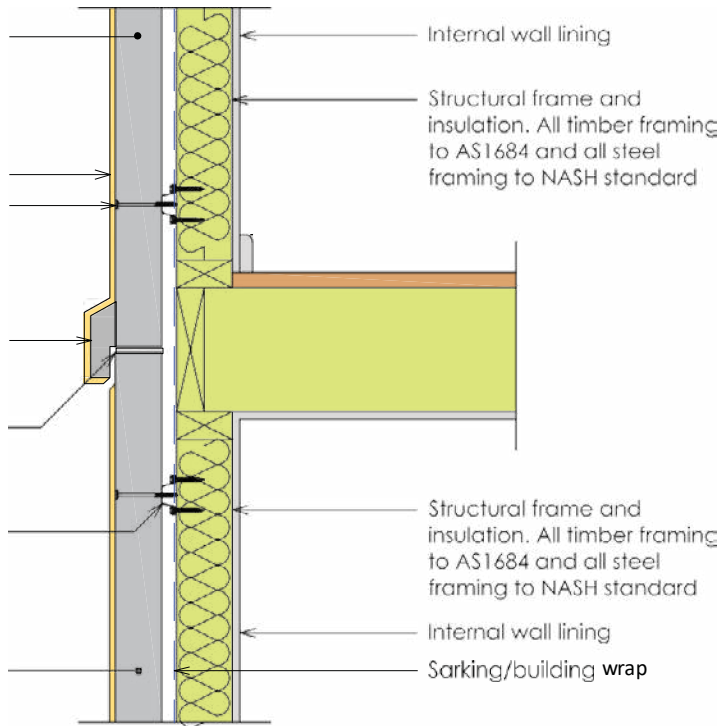

11b - Horizontal Control Joint  
- Flush Finish

Maxiwall AAC wall panel (physical characteristics of the panels can vary according to the acceptable tolerances shown in the properties and tolerances (table 1))

Approved exterior coating

Screw fix to 24 mm steel tophat batten. For fixing method refer to project engineer's specification and AS3566 Screws - Self Drilling.  
Note: NCC-BCA State variations apply.

Polystyrene backing rod and external grade (and fire rated if appropriate) polyurethane sealant to form a 10x10mm flexible joint

Screw fix to 24 mm steel tophat batten. For fixing method refer to project engineer's specification and AS3566 Screws - Self Drilling.  
Note: NCC-BCA State variations apply.

Maxiwall AAC wall panel (physical characteristics of the panels can vary according to the acceptable tolerances shown in the properties and tolerances (table 5))

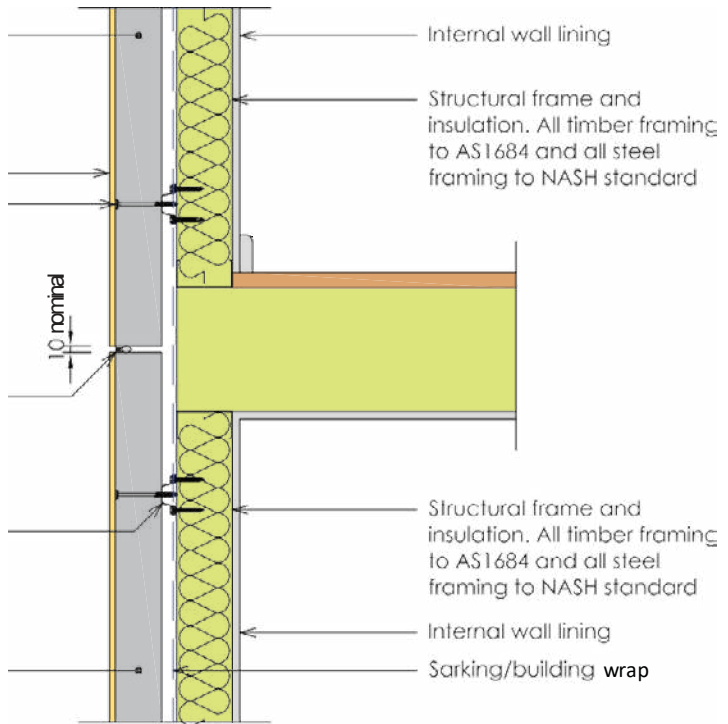

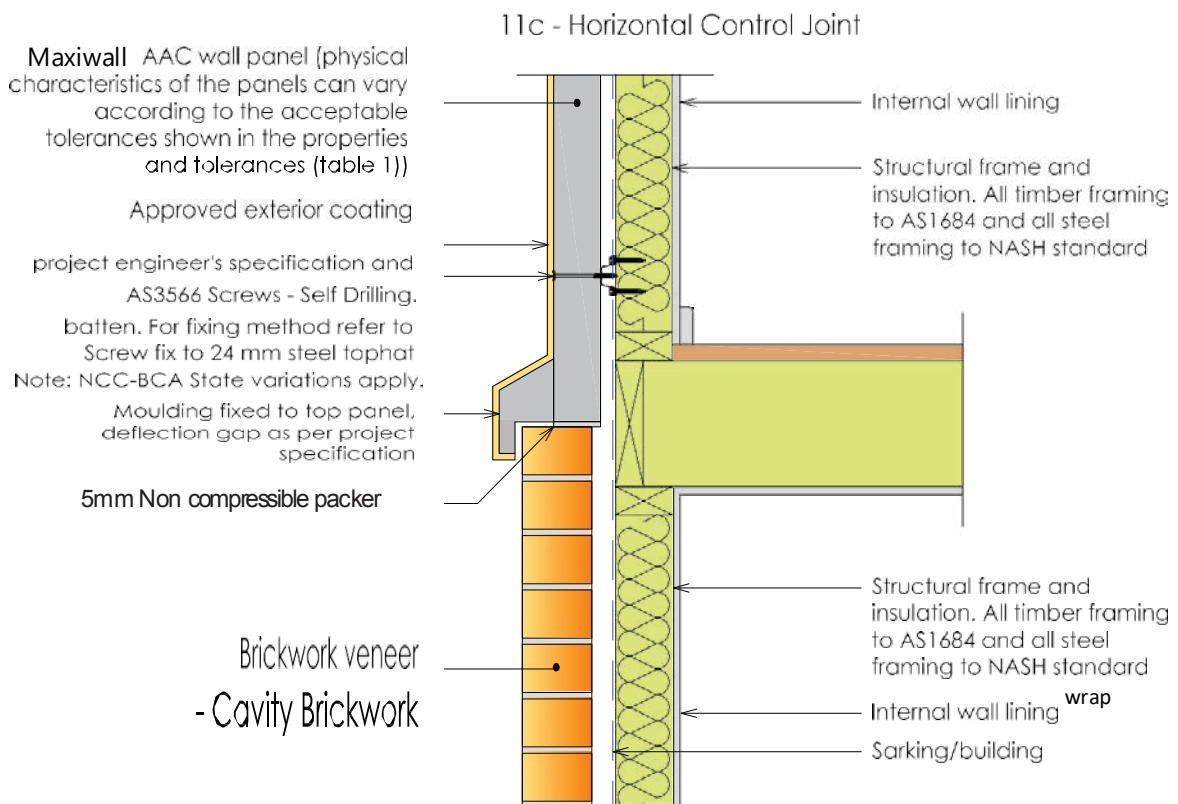

## 9.0 PRODUCT DECLARATION

### 1. DURABILITY & MAINTENANCE

Autoclaved aerated concrete has high porosity and relatively low alkalinity compared to traditional concrete. As a cement-based material, AAC resists water, rot, mold and mildew and can be precisely shaped and conform to tight tolerances when used in building construction.

MaxiWall panels have steel mesh that is coated with corrosion resistant paint applied in a two-dip coat process. If panels are cut apply anti-corrosion paint on the exposed steel. In typical applications the completed external wall system with moisture proof sealed joints is protected from moisture ingress with an external surface coating. Where there is significant and prolonged exposure to moisture a waterproof tanking membrane must be applied to the panel surface.

**TABLE 3. – ENERGY EFFICIENCY PERFORMANCE**

75mm Maxiwall® 413kg/m <sup>3</sup> System					Insulation path		Overall		Overall	
Assumes 75mm Maxiwall® thermal resistance is R0.60 m <sup>2</sup> .K/W for 4.0% moisture content							(Pine Framing 12.13% area)		(Steel Framing 5.8% area)	
Stud Frame	Top Hat Cavity	Wall thickness mm	Batts	Wall Wrap	Summer	Winter	Summer	Winter	Summer	Winter
64mm Stud Frame	24mm	173	None	None	1	1	1	1	1	1
		173	None	Thermoseal Wall Wrap XP Plus	1.9	2	1.9	2	1.9	2
		173	None	Polyair Performa 4.0 XHD	2.2	2.2	2.2	2.2	2.2	2.2
		173	70mm Bradford Soundscreen Batts R2.0	Thermoseal Wall Wrap XP	3.1	3.3	3.1	3.3	3.1	3.3
		173	70mm Bradford Soundscreen Batts R2.0	Enviroseal ProctorWrap RW	2.8	2.9	2.8	2.9	2.8	2.9
	35mm	184	None	None	1	1	1	1	1	1
		184	None	Thermoseal Wall Wrap XP Plus	1.9	2	1.9	2	1.9	2
		184	None	Polyair Performa 4.0 XHD	2.2	2.2	2.2	2.2	2.2	2.2
		184	70mm Bradford Soundscreen Batts R2.0	Thermoseal Wall Wrap XP	3.1	3.3	3.1	3.3	3.1	3.3
		184	70mm Bradford Soundscreen Batts R2.0	Enviroseal ProctorWrap RW	2.8	2.9	2.8	2.9	2.8	2.9
70mm Stud Frame	24mm	179	None	None	1	1	1	1	1	1
		179	None	Thermoseal Wall Wrap XP Plus	2	2.1	2	2.1	2	2.1
		179	None	Polyair Performa 4.0 XHD	2.2	2.2	2.2	2.2	2.2	2.2
		179	70mm Bradford Soundscreen Batts R2.0	Thermoseal Wall Wrap XP	3.3	3.4	3.3	3.4	3.3	3.4
		179	70mm Bradford Soundscreen Batts R2.0	Enviroseal ProctorWrap RW	2.9	3.1	2.9	3.1	2.9	3.1
	35mm	190	None	None	1	1	1	1	1	1
		190	None	Thermoseal Wall Wrap XP Plus	1.9	2	1.9	2	1.9	2
		190	None	Polyair Performa 4.0 XHD	2.2	2.2	2.2	2.2	2.2	2.2
		190	70mm Bradford Soundscreen Batts R2.0	Thermoseal Wall Wrap XP	3.3	3.4	3.3	3.4	3.3	3.4
		190	70mm Bradford Soundscreen Batts R2.0	Enviroseal ProctorWrap RW	2.9	3.1	2.9	3.1	2.9	3.1
90mm or 92mm Stud Frame	24mm	199	None	None	1	1	1	1	1	1
		199	None	Thermoseal Wall Wrap XP Plus	2	2	2	2	2	2
		199	None	Polyair Performa 4.0 XHD	2.2	2.2	2.2	2.2	2.2	2.2
		199	90mm Bradford Gold Wall Batts R2.0	Thermoseal Wall Wrap XP	3.2	3.4	3.2	3.4	3.2	3.4
		199	90mm Bradford Gold Wall Batts R2.5	Enviroseal ProctorWrap RW	3.4	3.6	3.4	3.6	3.4	3.6
		199	90mm Bradford Polymax Walls Batts R2.5	Enviroseal ProctorWrap RW	3.4	3.6	3.4	3.6	3.4	3.6
		199	90mm Bradford Gold Wall Batts R2.7	Enviroseal ProctorWrap RW	3.6	3.8	3.6	3.8	3.6	3.8
	35mm	210	None	None	1	1	1	1	1	1
		210	None	Thermoseal Wall Wrap XP Plus	1.9	2	1.9	2	1.9	2
		210	None	Polyair Performa 4.0 XHD	2.2	2.2	2.2	2.2	2.2	2.2
		210	90mm Bradford Gold Wall Batts R2.0	Thermoseal Wall Wrap XP	3.2	3.4	3.2	3.4	3.2	3.4
		210	90mm Bradford Gold Wall Batts R2.5	Enviroseal ProctorWrap RW	3.4	3.6	3.4	3.6	3.4	3.6
		210	90mm Bradford Polymax Walls Batts R2.5	Enviroseal ProctorWrap RW	3.4	3.6	3.4	3.6	3.4	3.6
		210	90mm Bradford Gold Wall Batts R2.7	Enviroseal ProctorWrap RW	3.6	3.8	3.6	3.8	3.6	3.8
Notes:	<ul style="list-style-type: none"> <li>• Above all for 10mm Plasterboard Plus lining.</li> <li>• The above results are for 75mm Maxiwall (dry density 413kg/m<sup>3</sup>) external wall system with assumed thermal resistance of R0.60 m<sup>2</sup>.K/W for 4.0% moisture content.</li> <li>• For 6mm skim render, Total R-values are R0.04 more than those above.</li> </ul>									

## 4. ACOUSTIC PERFORMANCE

There is no sound transmission performance requirement for external wall systems in the BCA. Where there is need for a specific requirement, such as local council regulations or for a particular purpose, the MaxiWall panels are expected to meet the acoustic properties listed in Table 4 – Sound Transmission Performance.

Acoustic performance of MaxiWall panels may be impacted if standard installation configurations shown in this manual are changed, such as increasing cavity widths or use of interior wall linings of a higher density and installation of thicker insulation products or plasterboard. A specialist acoustic consultant should be engaged if the project requires non-standard sound transmission performance.

**TABLE 4. - SOUND INSULATION PERFORMANCE**

WALL SYSTEM	DESCRIPTION	RW	RW + CTR
MaxiWall Panel System 1	10mm plasterboard 90mm timber stud Wall wrap 24mm top hat 75mm MaxiWall panel	38	23
MaxiWall Panel System 2	10mm plasterboard 90mm timber stud Wall wrap R2.0 glasswool batts 24mm top hat 75mm MaxiWall panel	41	26
MaxiWall Panel System 3	10mm plasterboard 90mm steel stud Wall wrap R2.5 glasswool batts 35mm top hat 75mm MaxiWall panel	42	27

## **5. QUALITY ASSURANCE**

Quality is important to our business. We strive to provide our customers with products and systems that meet and exceed their expectations. The manufacturing operations and quality assurance of MaxiWall panels have been independently audited and certified to meet the highest Australian standard.

MaxiWall panels used in the external wall systems for low-rise multi-residential buildings and houses are specifically developed to combine performance attributes for structural capacity, fire resistance and acoustic insulation. Subject to the conditions and exclusions set out under the MaxiWall Warranty

Statement, Big River warrants that the MaxiWall panels sourced from its manufacturing partners are free from defects in materials and manufacture.

## **6. SUSTAINABILITY**

Autoclaved aerated concrete offers sustainability in terms of material and performance. It uses approximately onequarter of the concrete raw material and incorporates large quantity of air resulting in fewer raw materials used per square meter than many other building materials. It also has superior insulation properties compared to concrete and conventional masonry and is about one-fifth of the mass of concrete. The air-tightness in the system creates an energy efficient envelope and prevents unwanted air losses compared to conventional frame construction thus reducing energy use.

## **10.0 COATING & WEATHERPROOFING**

### **1. DURABILITY & MAINTENANCE**

Autoclaved aerated concrete has high porosity and relatively low alkalinity compared to traditional concrete. As a cement-based material, AAC resists water, rot, mold and mildew and can be precisely shaped and conform to tight tolerances when used in building construction.

MaxiWall panels have steel mesh that is coated with corrosion resistant paint applied in a two-dip coat process. If panels are cut apply anti-corrosion paint on the exposed steel. In typical applications the completed external wall system with moisture proof sealed joints is protected from moisture ingress with an external surface coating. Where there is significant and prolonged exposure to moisture a waterproof tanking membrane must be applied to the panel surface.

Acid, certain salts and acidic gases can attack AAC and therefore special treatment and attention is required for applications subject to these conditions.



## **2. FIRE RESISTANCE**

MaxiWall panels in low-rise external wall system applications comply with the requirements of the National Construction Code for Fire Resistance Level, The wall system is applicable in situations where a Fire Resistance Level (FRL) of not more than 60/60/60 minutes is required. If an FRL in excess to what is stated herein is required please consult a design and building construction professional, as there are certain performance requirements that must be complied as outlined in the BCA.

## **3. ENERGY EFFICIENCY**

There are BCA requirements for energy and efficiency. BCA ratings depend on the type of construction and the building class and this can vary with each state and different parts in Australia. A total R-Value or resistance rating is the sum total of the R-Values of each of the building components. The higher the required Total R-Value the greater the insulation provided. Table 3 – Energy Efficiency Performance below shows the performance of the sample construction illustrated in this manual.

## **4. BUILDING WRAP**

The use of building wrap or sarking helps to control condensation and act as an air barrier to reduce energy loss through the walls in the building. The design and building construction professionals must approve the sarking configuration. The material selected and installed must comply with AS/NZS4200 Part 1 - Materials and Part 2 - Installation.

# **11.0 MATERIAL HANDLING**

## **PANEL UNLOADING**

MaxiWall panels are shipped in packs of 10, stacked on the longitudinal edge. The packs are strapped to strengthened timber bearers and are wrapped in resilient plastic sheeting. Crane slings and forklifts may be used in accordance with standard industry practice. The Project Engineer is cautioned regarding the initial delivery of the panel packs that should be unloaded as close as possible to the installation area. Secondary handling of the panels increases the risk of damage, and installation of damaged panels may void the warranty.

## **STORAGE & PROTECTION**

MaxiWall packs, when on construction site must be stored on a flat-grade level that is not prone to standing water, erosion or settling. It must be left on its edge to avoid sagging. The packs may be stacked up to 3 packs high on flat load-bearing stable platform so far as is reasonably practical and safe for workers and others. The packs should not be stacked if stored on un-level and natural ground.

MaxiWall panels should ideally be kept dry with attention paid to protecting panel ends, edges and surfaces. In adverse weather conditions the panels must be kept covered. Do not “shake-out” stored panels until they are ready to be installed. Excessive handling may cause damage. MaxiWall panels with a central single layer of reinforcement and length over 1800mm are at risk of cracking under their self-weight when carried or lifted from the horizontal or tilted from the vertical position. Adequate support must be provided when lifting. Panels must always be carried edge up. Lifting equipment must be used when necessary.

Most chipped corners and edges can be repaired with MaxiWall’s approved patching compounds. If reinforcing steel mesh is visible it must be protected using the approved touch-up paint. Panels that have surface or minor cracks are usable but if not sure contact your MaxiWall sales representative.

## **HEALTH & SAFETY**

Safety Data Sheets (SDS) will be provided with all MaxiWall panels including major components associated with the system such as coatings, patching compound, thin-bed adhesive and reinforcement touch-up paint. MaxiWall products contain Crystalline Silica (Quartz) that as dust is produced during cutting, grinding or drilling. It is categorized as a health hazard when inhaled. Approved dust mask and protective safety glasses or goggles must be worn for dust generating operations.

MaxiWall products are to be handled and worked on-site with the appropriate protective clothing. Protective gloves must be used for all construction operations. It is the responsibility of the builder/site supervisor to ensure that installation contractors adhere to safe work practices and suitable clothing.

## 12.0 MATERIAL PROPERTY

**TABLE 5. - MAXIWALL PANEL PHYSICAL PROPERTIES & TOLERANCES**

NO.	DESCRIPTION	CHARACTERISTICS	SPECIFICATIONS
1	Dimensional tolerance	Length Width Thickness	$\leq \pm 5.0$ mm $\leq \pm 1.5$ mm $\leq \pm 1.5$ mm
2	Physical	Nominal Dry density Average Working Density	$\leq 400$ kg $\leq 540$ kg
3	Strength	Compressive strength Modulus of rupture	$\leq 2.8$ Mpa $\leq 0.4$ Mpa
4	Acoustic	Weighted sound reduction	30 dB
5	Thermal	Thermal resistance value (R-value)	0.60

**TABLE 6. - WALL SYSTEM THICKNESS COMPARISON**

WALL SYSTEMS	WALL ELEMENT WIDTH (MM)			TOTAL WIDTH (MM)
	STUD	CAVITY	MASONRY LEAF	
Brick veneer	70	40	110	220
MaxiWall panel	70	24 - 35	75	169 - 180
Brick veneer	90	40	110	240
MaxiWall panel	90	24 - 35	75	189 - 200

**TABLE 5. - MAXIWALL PANEL WEIGHT INFORMATION**

LENGTH (MM)	PANEL WEIGHT (KG)	PALLET WEIGHT (KG)
1800	44	445
2400	58	585
2550	62	625
2700	66	665
2850	69	695
3000	73	735
Thickness 75mm, Width 600mm		

## 13.0 STANDARD & COMPLIANCE

### APPENDIX A

NO.	STANDARD COMPLIANCE	CHARACTERISTICS
	BCA Vol. One 2022 B1P1 (1),(2),(a),(b),(c)	For non-load bearing internal wall systems for high-rise residential and commercial buildings.
2	BCA Vol. One 2022 Specification 8	External attachments to fire resistance level of up to 60/60/60 including SA state variation C1.1 (a) (v).
3	BCA Vol. One 2022: F3P1	Applicable to prevention of water penetration of external walls.
4	BCA Vol. One 2022: F7P4	For non-load bearing walls, including NT state and territory variations.
5	BCA Vol. One 2022: Part J4D6	R-values vary with installation configurations and must satisfy achievement of minimum R-values for the stated climate zones. Refer to manufacturer's specification and Table J1.5a.
6	BCA Vol. Two 2022: H1P2	Applicable to prevention of water penetration of external walls.
7	BCA Vol. Two 2022 H7P5	For external walls including TAS state variations for AAC panels. Due consideration should be given to fire resistance of other components used in construction.
8	BCA Vol. Two 2022 H4P6	For non-load bearing walls, including NT state and territory variations. Acoustic performance of wall panel system is dependent on construction of wall system. Refer to manual for guidance.
9	BCA Vol. Two 2022 H7D4	For external walls including NSW, QLD, SA and TAS state variations for AAC panels. Due consideration should be given to fire resistance of other components used in construction.
10	AS 1720	Timber Framing Code
11	AS 1684 - 1999	National Timber Framing Code
12	AS 2870 - 2011	Residential slab and footing construction
13	AS 3959 - 2009	Construction of buildings in bushfire – prone zone areas
14	AS 2904 - 1995	Damp-proof course and flashings
15	AS 3600 - 2009	Concrete structures
16	AS 1170 Part 1	Loading Code
17	AS 1170 Part 2	Wind Code
18	AS 3660.1 – 2014	Protection of building against subterranean termite – Part 1 New building
19	AS 4055 - 2012	Wind loading for housing
20	AS 3623/ASNZ 4600	Steel Framing
21	NASH Standard 2005	Steel framing – Part 1
22	AS/NZS 1170.0: 2002	Structural design actions – Part 0,1 & 2
23	AS 1530.4 - 2005	Methods for fire tests on building materials, components and structures – Part 4
24	AS 1684.1 - 1999	Residential timber – frame construction – Part 1: Design criteria
25	AS1684.2 - 2010	Residential timber – frame construction – Part 2 : Cyclonic areas
26	AS 1720.1 - 2010	Timber Structures – Part 1: Design methods
27	AS 3566.1 2002	Self – drilling screw for the building and construction industries – Part 1 & 2
28	AS 4055 - 2002	Wind loads for housing
29	BS EN 12602:2008	Prefabricated reinforced components of autoclaved aerated concrete.

## 14.0 RESPONSIBILITY & WARRANTY



### RESPONSIBILITY

The final specification and certification of the external wall system using MaxiWall 75mm AAC wall panels lie solely with qualified design and building construction professionals responsible for the project. These professionals would generally comprise of structural engineers, fire engineers and acoustic engineers. The design consideration, fixing specifications and installation details in this manual represent common types of construction and detailing practice used in Australia. A competent professional must approve any variations or alternatives to the technical information described in this manual.

### DISCLAIMER

The information contained in this technical manual is only advisory and general in nature. It is not intended to substitute advice or consultation from registered building construction professionals to ensure designs, systems and installation for projects conform to the National Construction Code and Building Codes of Australia including any other laws imposed by the States or local councils. The user of this manual understand and agree that MaxiWall, its member companies, its officers, agents and employees shall not be liable in any manner under any theory of liability for the user's reliance on this manual. The user agrees to release, hold harmless and indemnify MaxiWall, its member companies, successors, assigns, officers, agents and employees from any and all claims of liability, costs, fees (including lawyer's fees), or damages arising in any way out of the use of this information.



## PRODUCT WARRANTY

### MaxiWall 75mm Autoclaved Aerated Concrete Panels

<b>Provided by:</b>	Big River Group Pty Ltd Trenayr Road, Junction Hill NSW 2460 <b>1300 881 958</b>
<b>Product type:</b>	MaxiWall 75mm autoclaved aerated concrete panels.
<b>Warranty statement:</b>	Big River warrants that its MaxiWall 75mm autoclaved aerated concrete (AAC) building panels are free from defects in materials and manufacture subject to the conditions and exclusions set out in the Product Warranty.
<b>Warranty cover:</b>	This Warranty covers the above product type that has defects in materials or workmanship due solely to improper manufacture. Defects include but not limited to structural defects, dimensional discrepancies beyond acceptable tolerances and failure to meet product quality standards and specifications as set forth in our approved Technical Manuals.
<b>Warranty conditions:</b>	This Warranty shall only apply where the relevant building system constructed complies with Big River approved Technical Manuals for High- Rise Residential Internal Wall System and External Wall Panels for Low-Rise Residential Buildings. Ensure registered professionals, such as licensed builders, architects and engineers are consulted to determine that the design, system and installation are suitable for the project and conforms to the Building Code of Australia.
<b>Warranty period:</b>	Subject to the conditions and exclusions, set out under this Warranty, Big River warrants that its MaxiWall AAC 75mm panels are sourced from reputable manufacturers or suppliers and are covered by their respective guarantees or warranties and any warranties imposed by the Australian Consumer Law. The term of warranty is 20 years from the date of purchase.



## PRODUCT WARRANTY

<b>Warranty exclusion:</b>	This Warranty shall not cover any defect arising from non-compliance of structural design in accordance to the Building Code of Australia, faulty installation, environmental conditions that are beyond Big River control, modifications, alterations, failure to comply with the conditions of cover, force majeure or any other cause or damage not resulting from defects in materials or workmanship due solely to improper manufacture.
<b>Warranty settlement:</b>	Subject to the legal rights of a consumer under law, if any of the MaxiWall AAC 75mm panels are so defective, Big River will, subject to verification and inspection of such defects by a MaxiWall representative and at its sole option: either replace the products or supply equivalent products, repair the defective products or reimburse for the replacement and repair of the products. Big River will not be liable for any punitive, indirect, special, incidental or consequential damages other than what is stated in the Product Warranty.
<b>Associated materials warranty:</b>	This Warranty does not cover any materials, components or system associated with or supplied by third parties. Please refer to your supplier's warranty terms and conditions.
<b>Warranty Claims:</b>	Homeowners should contact their Builders. Builders wishing to make a claim under this Warranty should contact an authorised Big River distributor or representative. Otherwise please contact Big River directly on 1300 881 958. Claims for warranty must be presented in writing to Big River and will require proof of purchase itemizing the panel sizes, and batch numbers, name of project and nature of defects along with the proof when the panels were installed.

*Except as provided herein, Big River makes no express or implied warranties. This Warranty is exclusive of all other warranties and shall not be extended, altered or varied except by a written instrument signed by an authorised representative of Big River.*





SCAN HERE TO  
LEARN MORE  
INFORMATION  
ON MAXIWALL  
AAC PANELS



## CONTACT US

For all sales and technical enquiries please contact the experts at Big River:

**Phone:** 1300 881 958

**Email:** [info@bigrivergroup.com.au](mailto:info@bigrivergroup.com.au)

For your nearest Big River branch or to download information:

**Visit:** [www.bigrivergroup.com.au](http://www.bigrivergroup.com.au)



WE'RE  
BIG RIVER  
GROUP

  
**BIG RIVER**  
COMMERCIAL

  
**BIG RIVER**  
TRADE CENTRE

  
**BIG RIVER**  
PANELS

  
**TIMBERWOOD**  
PANELS

  
**PLYTECH**  
PANELS